

2023

catalogue - price list



emergency
lighting



Luznor Desarrollos Electrónicos, S. L., is a company specialized in the design and manufacturing of electronic security devices since its establishment in Vitoria-Gasteiz (Álava) in the year 1998.

LOCAL MANUFACTURING

The products developed by Luznor can be classified into three main groups: emergency lighting, professional torches and battery charging equipment, and are entirely developed in its single production plant.

At the same time, Luznor has always had as a principle to consolidate ties with local suppliers, ensuring a relationship of trust, a high quality perceived in the products and a transfer from R&D&i to market launch as quickly and efficiently as possible.

As reference numbers, around 80% of Luznor's supplies come from Basque suppliers and more than 95% of the investments are also made to Basque companies, promoting the growth of the nearby business network.

QUALITY

The certificate of the ISO 9001:2015 Quality Management standard since 2003 is a guarantee of the quality of Luznor's products, as well as the deep-rooted philosophy of the company of commitment to customers, offering a technical service highly valued by them.

Of course, all products comply with the applicable European Parliament and Council Directives to comply with Directive 93/68/EEC of CE marking.

RESEARCH, DEVELOPMENT & INNOVATION

Regarding its staff, Luznor has a doctorate in Applied Physics from the University of the Basque Country, five engineers and five industrial technicians, which allows the company to have the necessary skills to carry out its continuous research activity.

With 20% of the staff dedicated to R&D&i, the company is focused on product/service innovation using emerging technologies and new materials, improving manufacturing processes and always taking into account the sustainability of the resources used.

ENVIRONMENT

The company's commitment to the environment was made clear in 2019 by obtaining the ISO 14001:2015 Environmental Management certificate.

Likewise, Luznor won the *Green Pact Award for Good Environmental Practices* in 2019 in its fifth edition in the SME category, awarded by the Vitoria-Gasteiz City Council.

SOCIETY

Equality is a fundamental aspect for Luznor, ensuring it in all its possible forms. Since its creation, Luznor has promoted the integration of women in the industrial environment, always maintaining a percentage greater than 55% of them in the workforce and, for this reason, receiving the *First Arguilan Company and Employment Award for Equality* in 2006.

As an advanced manufacturing company, one of the Basque Country's RIS3 Smart Specialization Strategic Priorities, Luznor has made, since its creation, an important contribution to certain industrial sectors, specifically construction, transport and citizen security.

By aligning its industrial activity with the Sustainable Development Goals, Luznor helps to meet the world's technological, energy and social challenges, for example, by offering quality employment.

POSITIONING

Luznor's greatest differential value is its capability, thanks to a high level of specialization, to offer customized solutions according to the requirements set forth, ranging from its electronic and mechanical design to its validation through the relevant tests and approvals in official laboratories.

Luznor Brand is, thus, synonymous with personalized developments of maximum reliability, positioning itself, with an approximate export rate of 15%, in a market niche with high added value at an international level.

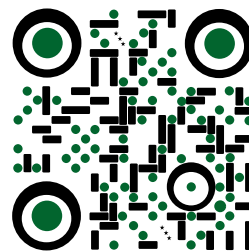

c/ Paduleta, 47 (Júndiz)
01015 Vitoria-Gasteiz (Álava)
Spain

www.luznor.com
luznor@luznor.com

Tel. (+34) 945 200 961

Contents

EMERGENCY LUMINAIRES



Polar Series 7
+ Autotest 9



Orión Series..... 11



Dome Series..... 13



Tabled Series 15



G Led Series 19



G Basic Led Series 21
+ Autotest 25



Accessories G Series..... 26



L Led Series 29



L Basic Led Series 31
+ Autotest 33



Accessories L Series..... 34

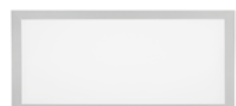

LLD Series 37



LLE Series..... 39



Remote control 41

BEACON LIGHTS



Matiz Self-contained 43
Matiz Centralized..... 47



Accessories Matiz 49



Élite Self-contained 51
Élite Centralized..... 53



Accessories Élite 54



PCM Centralized..... 57

LINEAR EMERGENCY FITTINGS



LN Series 59
+ Autotest 61



Tube Series 63

EMERGENCY CONVERSION KITS



K1 Series 64



K2 Series 65

EMERGENCY FLOODLIGHTS



PL Series 67



PH Series 71
+ Autotest 73



PLN Series 77



LH Series 79

LOW TEMPERATURES



FI Led Series 81

BATTERY CHARGING EQUIPMENT



CB Series 83



CBQ Series 85

ADDITIONAL INFORMATION

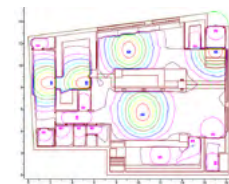

PCI Software 86
Interdistances 86



Autotest 87

Sales terms 2023 88

Legislation 89

The information contained in this emergency lighting catalogue is valid from the date of publication, except in the case of typographical errors. Luznor reserves the right to change them without prior notice. This list of references and prices replaces any other previously published.



Polar Series

The most minimalist emergency light. Circular and flush design. Light source consisting of 6 white crown-shaped LEDs, with a choice of colour temperature: 5,700 K (cold light) or 3,000 K (warm light). Set comprising luminaire kit, kit module and battery. Remote controllable.



Non-maintained

model	Φ (lm)	A (h)	P net (W)	RRP (€)
MB-300-BT	300	1	2.0	71.97
MB-200-BT	200	1	1.5	65.55
MB-200-2-BT	200	2	2.0	68.33
MB-150-3-BT	150	3	2.0	68.33

Maintained

model	Φ (lm)	A (h)	P net (W)	RRP (€)
MB-300P-BT	300	1	6.5	84.61
MB-200P-BT	200	1	4.0	78.08
MB-200P-2-BT	200	2	4.5	80.97
MB-150P-3-BT	150	3	3.7	80.97

Centralizable luminaires

model	Φ (lm)	P net (W)	modules	power supply	RRP (€)
MB-200L-BT	200	2.5	luminaire + kit	85÷265 Vac and 120÷370 Vdc	47.19
MB-200L-BT (12Vdc)	200 or 100	2.0 or 1.0	luminaire	12 Vdc	42.46
MB-200L-BT (24Vdc)	200 or 100	2.0 or 1.0	luminaire	24 Vdc	42.46

To request different body finish and/or different diffuser type, change the corresponding letters in the reference. To request a colour temperature of 3,000 K, add "W" to the reference. To request IP55 degree of protection, add "E" to the end of the reference. Example:

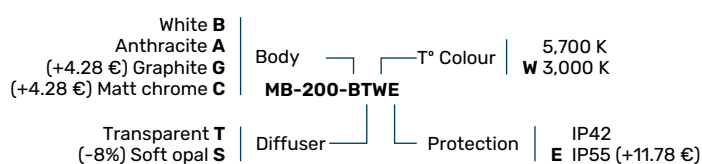

◇ Interdistances on page 86.

◇ Dimensions on page 9.

◇ Ni-Cd (HT) battery.

◇ The development of the centralizable luminaires of 300 and 150 lm is available on demand.

Kit module



Battery



Luminaire module





Polar Series AUTOTEST

The most minimalist emergency light with Autotest function: a microprocessor checks the status of the emergency LEDs, the battery and the electronics on a regular basis. Light consisting of 6 white LEDs (5,700 K or 3,000 K) in the shape of a crown. Set consisting of luminaire module, kit module and battery. Remote controllable.



Non-maintained

model	Φ (lm)	A (h)	P net (W)	RRP (€)
MBA-300-BT	300	1	2.0	99.80
MBA-200-BT	200	1	1.5	93.37
MBA-200-2-BT	200	2	2.0	96.16
MBA-150-3-BT	150	3	2.0	96.16

To request different body finish and/or diffuser type, change the corresponding letters in the reference. To request a colour temperature of 3,000 K, add "W" to the reference. To request IP55 degree of protection, add "E" at the end of the reference. Example:

White B	Body	T° colour	5,700 K
Anthracite A			
(+4.28 €) Graphite G			
(+4.28 €) Matt chrome C			
MBA-200-BTWE			W 3,000 K
Transparent T	Diffuser		
(-8%) Soft opal S			
IP42	Protection		
(+11.78 €) IP55 E			

◇ Ni-Cd (HT) battery.

◇ Information about Autotest on page 87.

◇ Interdistances on page 86.

Maintained

model	Φ (lm)	A (h)	P net (W)	RRP (€)
MBA-300P-BT	300	1	6.5	112.43
MBA-200P-BT	200	1	4.0	105.91
MBA-200P-2-BT	200	2	4.5	108.79
MBA-150P-3-BT	150	3	3.7	108.79

Flush mounting

Luminaire module

Cut: Ø55 mm

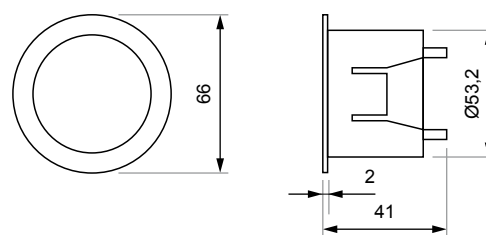

Kit module

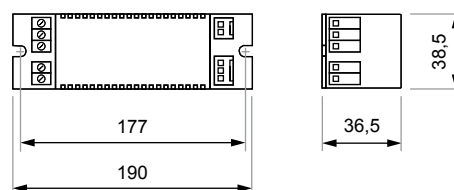

Battery module

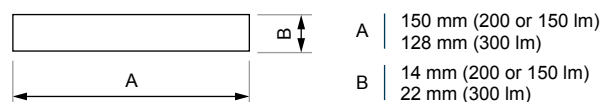



Orión Series

Circular emergency luminaire of the highest aesthetic and functional quality, for environments of great social value such as hotels or hospitals. Choice of: maintained mode, with 8 LEDs arranged in a crown with cool (5,700 K) or warm (3,000 K) colour temperature, or non-maintained. Compatible with the Dome Series. Remote controllable.



In emergency mode, the 4 central LEDs light up, always at 5,700 K. If the Orión was in maintained mode before going into emergency mode, the LED crown is switched off.

The 8 LED crown can be set at 5,700 K or 3,000 K to light when the Orión is on mains, if the maintained mode is chosen. For the crown not to light and the Orión is in non-maintained mode, a connector inside the Orión needs to be repositioned.

Maintained / Non-maintained

model	Φ (lm) emerg	Φ (lm) main	P net NM (W)	P net M (W)	A (h)	RRP (€)
OR-200-T	200	100	1.0	1.6	1	64.26
OR-100-2-T	100	100	1.0	1.6	2	64.26

To request a different diffuser type, change the corresponding letter of the reference. To request a colour temperature of 3,000 K in maintained lighting, add "W" to the reference. To request an IP67 degree of protection, add "E" at the end of the reference. Example:

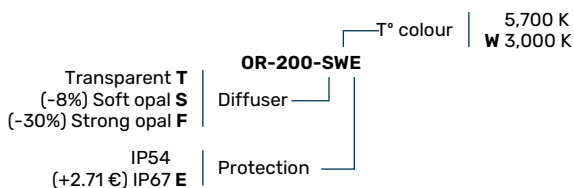

- ◇ Accessories and finishes on page 13.
- ◇ Ni-Cd (HT) battery.
- ◇ Only part of the Dome needs to be replaced to convert it into an Orión: the installation remains unchanged, energy efficiency and lighting performance are gained, and costs and waste are saved.



Surface mounting

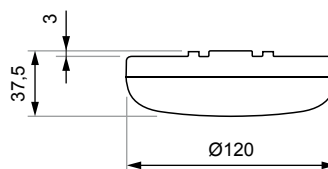

Recessed mounting

Hollow surface

Cut: Ø130 mm

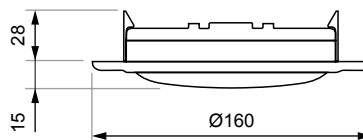

Solid surface

Cut: Ø150 mm

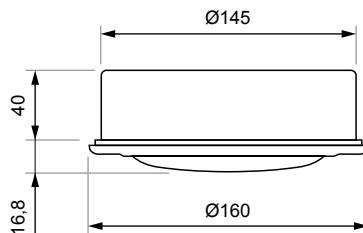



Dome Series

Circular residential emergency luminaire, designed for residential, hotel and hospital environments. Illumination by means of a single LED (colour temperature: 5,700 K). Four possible levels of luminous flux, both emergency and maintained, allowing dim and pleasant ambient or night-time lighting with minimum consumption.

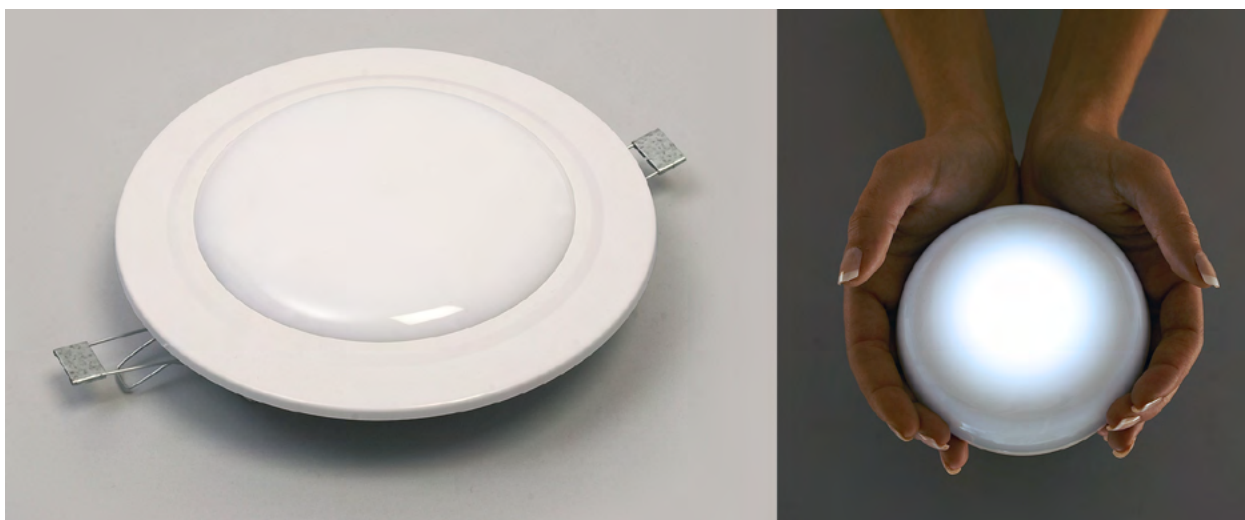

Maintained

model	emergency	remote	P net (W)	RRP (€)
DOME-T	yes (Ni-Cd HT)	no	3.0	69.75
DOME-T2	yes (Ni-Cd HT)	yes	3.0	76.98
DOME-T3	no	no	2.3	57.97

To request a different diffuser type, change the corresponding letter in the reference. To request an IP67 degree of protection, add "E" at the end of the reference. Example:

DOME-OE

- Diffusor | **T** Transparent
- | **O** Opal
- Protection | **IP54**
- | **E** IP67 (+2.71 €)

Internal connector

position	Φ (lm) main	Φ (lm) emerg	A (h)
1	77.0 (70%)	110 (100%)	1.3
2	44.0 (40%)	77 (70%)	2.0
3	11.0 (10%)	55 (50%)	3.0
4	1.1 (1%)	33 (30%)	5.0



Surface mounting

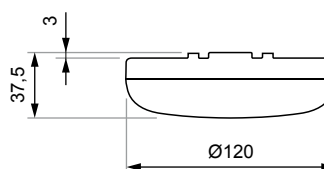

Recessed mounting

Hollow surface

Cut: Ø130 mm

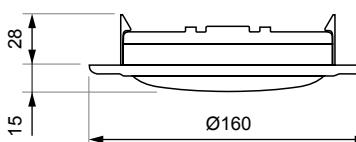

Solid surface

Cut: Ø150 mm

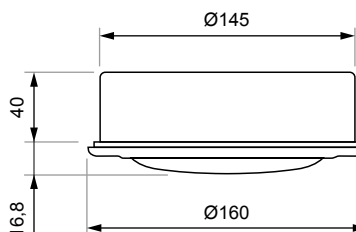

Recessing frame

White

Ref. MADOME-B
RRP. 4.70 €

Matt chrome

Ref. MADOME-C
RRP. 10.93 €

Masonry box

Ref. CEDOME
RRP. 7.99 €



Tabled Series

Emergency luminaire with a ground-breaking design and unique characteristics on the market, thanks to the possibility of orienting the luminaire at 7 different angles. Modern, uniform lighting made up of an extra-flat LED panel (colour temperature: 5,000 K). Choice of maintained or non-maintained mode. Pre-plate connection system. Remote controllable.



Maintained / Non-maintained

model	Φ (lm)	A (h)	P net (W)	RRP (€)
TL-110P-T	118	1	3.6 / 2.0	78.38
TL-230P-T	235	1	4.3 / 2.0	83.73
TL-350P-T	353	1	5.2 / 2.0	93.55
TL-470P-T	470	1	6.5 / 2.0	107.36
TL-580P-T	588	1	7.4 / 2.0	120.89
TL-110P-2-T	118	2	3.6 / 2.0	88.20
TL-170P-2-T	176	2	4.3 / 2.0	98.23
TL-230P-2-T	235	2	4.3 / 2.0	106.79
TL-290P-2-T	294	2	5.2 / 2.0	120.65
TL-70P-3-T	78	3	3.6 / 2.0	88.20
TL-110P-3-T	118	3	3.6 / 2.0	91.61
TL-150P-3-T	157	3	4.3 / 2.0	106.79
TL-190P-3-T	196	3	4.3 / 2.0	113.59



To request a different diffuser type, change the corresponding letter of the reference. Example:

TL-110P-T
 Diffusor | T Transparent
 S Soft opal (-8%)
 F Strong opal (-30%)

- ◇ Ni-Cd (HT) battery.
- ◇ Protection rating: IP44.
- ◇ Orientation of the LED panel in 7 angles compared with the body: 0°, 15°, 30°, 45°, 60°, 75° and 90°.

Surface mounting

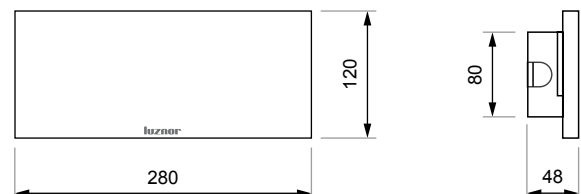

- ◇ Accessories and signalling on page 16.



Tabled Series ACCESSORIES AND SIGNALLING

Flush mounting

Frames for flush mounting in hollow surface



Matt chrome
Ref. MT-C
RRP. 13.08 €

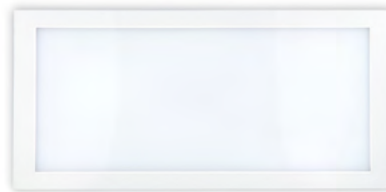

White
Ref. MT-B
RRP. 6.32 €

Cut: 292 x 130 mm

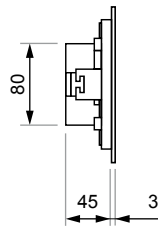
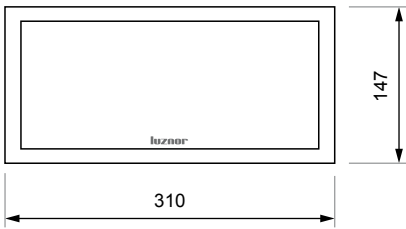

Anthracite
Ref. MT-A
RRP. 6.32 €

Recessed mounting

Spring kit

Cut: 260 x 90 mm

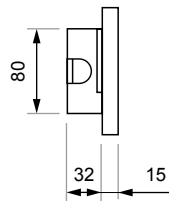
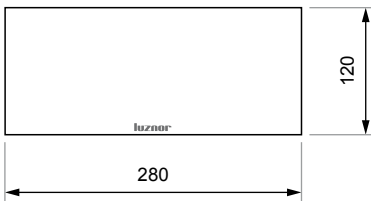

Ref. MS-T
RRP. 4.25 €



Suspended mounting

Suspension kit

Rod length: 0.25 m

Ref. CS-T
RRP. 20.66 €

Rod length: 0.75 m

Ref. CS-T (75 cm)
RRP. 33.05 €

Rod length: 1 m

Ref. CS-T (100 cm)
RRP. 33.05 €



Signs and pictograms



Ref. R1
200 x 50 mm
RRP. 2.75 €



Ref. R2
200 x 50 mm
RRP. 2.75 €



Ref. R3
200 x 100 mm
RRP. 2.75 €



Ref. R4
200 x 100 mm
RRP. 2.75 €



Ref. R5
200 x 100 mm
RRP. 2.75 €



Ref. R8
200 x 100 mm
RRP. 2.75 €



Ref. R11
200 x 100 mm
RRP. 2.75 €



Ref. P1
300 x 100 mm
RRP. 2.75 €



Ref. P2
200 x 100 mm
RRP. 2.75 €



Ref. P3
200 x 100 mm
RRP. 2.75 €





G Led Series

Design and style. LED strip lighting (colour temperature: 5,000 K) with internal diffuser. The lower part of the emergency light is illuminated by three coloured LEDs (ambient or corporate), highlighting its attractive shape. Choice of maintained or non-maintained mode. Pre-plate connection system. Remote controllable.



Maintained / Non-maintained

model	Φ (lm)	A (h)	P net (W)	RRP (€)
GL-110P-TTB	118	1	4.7 / 3.4	67.94
GL-230P-TTB	235	1	5.9 / 3.4	72.59
GL-350P-TTB	353	1	6.7 / 3.4	81.12
GL-470P-TTB	470	1	7.9 / 3.4	93.08
GL-580P-TTB	588	1	8.6 / 3.4	104.82
GL-110P-2-TTB	118	2	4.7 / 3.4	76.47
GL-170P-2-TTB	176	2	5.9 / 3.4	85.16
GL-230P-2-TTB	235	2	5.9 / 3.4	92.59
GL-290P-2-TTB	294	2	6.7 / 3.4	104.60
GL-70P-3-TTB	78	3	4.7 / 3.4	76.47
GL-110P-3-TTB	118	3	4.7 / 3.4	79.42
GL-150P-3-TTB	157	3	5.9 / 3.4	92.59
GL-190P-3-TTB	196	3	5.9 / 3.4	98.48

To request a different internal and external diffuser type and/or different ambient LED colour, change the corresponding letters of the reference. Example:

GL-110P-TTA

Colour LEDs | B □ Y ■ V ■ A ■ R ■

Internal diffuser | T Transparent
S Soft opal (-8%)
External diffuser | F Strong opal (-30%)

Surface mounting

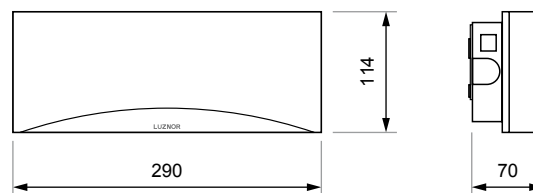

- ◇ Internal diffuser: allows for optimum protection of the LEDs and homogeneous illumination.
- ◇ Protection rating: IP44.
- ◇ Ni-Cd (HT) battery.
- ◇ Accessories y signalling on page 26.
- ◇ Pre-plate connection system: guides the wiring and allows the electrical connection without the need to open or manipulate the emergency luminaire, which is simply fitted by snapping it onto the pre-plate previously installed.





G Basic Led Series

Design and style in a simplified version. Illumination by LED strip (colour temperature: 5,700 K) without internal diffuser. Possibility of adding three coloured LEDs (ambient or corporative) that light up the lower part of the emergency luminaire, highlighting its attractive shape. Pre-plate connection system. Remote controllable.



Non-maintained

model	Φ (lm)	A (h)	P net (W)	RRP (€)
GL-100-T	100	1	1.4	40.11
GL-150-T	150	1	1.4	42.35
GL-200-T	200	1	1.4	44.57
GL-250-T	250	1	2.7	46.81
GL-300-T	300	1	2.7	49.03
GL-350-T	350	1	2.7	51.26
GL-400-T	400	1	2.7	53.49
GL-450-T	450	1	2.7	55.71
GL-100-2-T	100	2	1.4	44.57
GL-150-2-T	150	2	2.7	49.03
GL-200-2-T	200	2	2.7	53.49
GL-250-2-T	250	2	2.7	57.95
GL-100-3-T	100	3	2.7	49.03
GL-150-3-T	150	3	2.7	55.71

Maintained

model	Φ (lm)	A (h)	P net (W)	RRP (€)
GL-100B-T	100	1	2.7	53.49
GL-150B-T	150	1	3.2	55.71
GL-200B-T	200	1	3.7	57.95
GL-250B-T	250	1	5.7	60.17
GL-300B-T	300	1	6.2	62.39
GL-350B-T	350	1	6.6	64.63
GL-400B-T	400	1	7.1	66.85
GL-450B-T	450	1	7.6	69.08
GL-100B-2-T	100	2	2.7	57.95
GL-150B-2-T	150	2	4.5	62.39
GL-200B-2-T	200	2	5.0	66.85
GL-250B-2-T	250	2	5.7	71.32
GL-100B-3-T	100	3	3.9	62.39
GL-150B-3-T	150	3	4.5	69.08

To request a different diffuser type, change the corresponding letter of the reference. To request the incorporation of the three ambient LEDs, add the corresponding letter to the reference. Example:

GL-300-TV

Colour LEDs | B □ Y ■ V ■ A ■ R ■ (+4,99 €)

Diffuser | T Transparent
S Soft opal (-8%)
F Strong opal (-30%)

Surface mounting

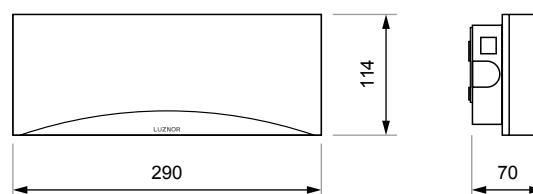

- ◇ Protection rating: IP44.
- ◇ Ni-Cd (HT) battery.
- ◇ Accessories and signalling on page 26.

- ◇ Pre-plate connection system: guides the wiring and allows the electrical connection without the need to open or manipulate the emergency luminaire, which is simply fitted by snapping it onto the pre-plate previously installed.







G Basic Led Series AUTOTEST

Design and style with Autotest function: a microprocessor checks the status of the emergency LEDs, battery and electronics on a regular basis. Illumination by LED strip (colour temperature: 5,700 K) without internal diffuser. Possibility of adding three coloured LEDs (ambient or corporative) in the lower part. Remote controllable.



Non-maintained

model	Φ (lm)	A (h)	P net (W)	RRP (€)
GLA-100-T	100	1	1.4	67.93
GLA-150-T	150	1	1.4	70.18
GLA-200-T	200	1	1.4	72.40
GLA-250-T	250	1	2.7	74.62
GLA-300-T	300	1	2.7	76.86
GLA-350-T	350	1	2.7	79.03
GLA-400-T	400	1	2.7	81.31
GLA-450-T	450	1	2.7	83.54
GLA-100-2-T	100	2	1.4	72.40
GLA-150-2-T	150	2	2.7	76.86
GLA-200-2-T	200	2	2.7	81.31
GLA-250-2-T	250	2	2.7	85.76
GLA-100-3-T	100	3	2.7	76.86
GLA-150-3-T	150	3	2.7	83.54

Maintained

model	Φ (lm)	A (h)	P net (W)	RRP (€)
GLA-100B-T	100	1	2.7	81.31
GLA-150B-T	150	1	3.2	83.54
GLA-200B-T	200	1	3.7	85.76
GLA-250B-T	250	1	5.7	88.00
GLA-300B-T	300	1	6.2	90.22
GLA-350B-T	350	1	6.6	92.45
GLA-400B-T	400	1	7.1	94.68
GLA-450B-T	450	1	7.6	96.90
GLA-100B-2-T	100	2	2.7	85.76
GLA-150B-2-T	150	2	4.5	90.22
GLA-200B-2-T	200	2	5.0	94.68
GLA-250B-2-T	250	2	5.7	99.14
GLA-100B-3-T	100	3	3.9	90.22
GLA-150B-3-T	150	3	4.5	96.90

To request a different diffuser type, change the corresponding letter in the reference. To request the incorporation of three coloured LEDs, add the corresponding letter of the reference. Example:

GLA-300-FB

Colour LEDs | B □ Y □ V □ A □ R □ (+4,99 €)

Diffuser | T Transparent
S Soft opal (-8%)
F Strong opal (-30%)

- ◇ Protection rating: IP44.
- ◇ Ni-Cd (HT) battery.
- ◇ Information about Autotest on page 87.
- ◇ Accessories and signalling on page 26.

Surface mounting

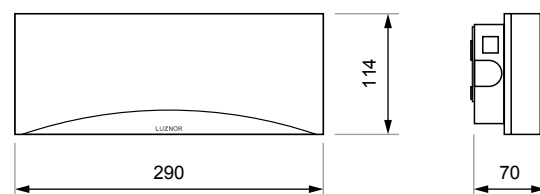

- ◇ Pre-plate connection system: guides the wiring and allows the electrical connection without the need to open or manipulate the emergency luminaire, which is simply fitted by snapping it onto the pre-plate previously installed.

G (Basic) Led Series ACCESSORIES AND SIGNALLING

Flush mounting

Frames for flush mounting in hollow surface

Cut: 298 x 124 mm

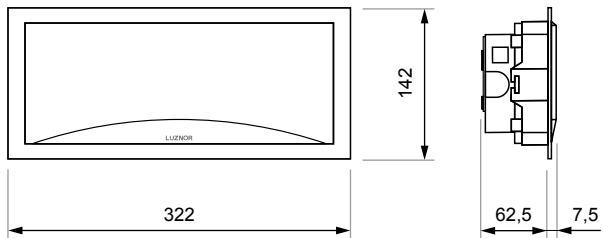

White
Ref. MG-B
PVP. 6.32 €

Matt chrome
Ref. MG-C
RRP. 13.08 €

Recessed mounting

Spring kit

Cut: 274 x 98 mm

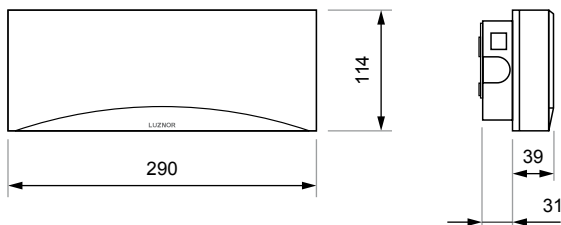

Ref. MS-G
RRP. 4.25 €

Watertight mounting

IP65 watertight box

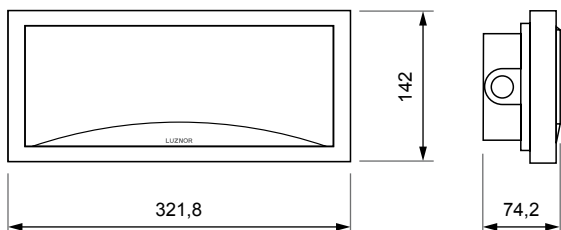

Ref. BE-G
RRP. 19.74 €

Ceiling banner

Transparent
Ref. BG-T
RRP. 20.66 €

Soft opal
Ref. BG-S
RRP. 20.66 €



Suspended mounting

Suspension kit

Rod length: 0.25 m
Ref. CS-G
RRP. 20.66 €

Rod length: 0.75 m
Ref. CS-G (75 cm)
RRP. 33.05 €

Rod length: 1 m
Ref. CS-G (100 cm)
RRP. 33.05 €



G (Basic) Led Series ACCESSORIES AND SIGNALLING

Flush mounting in masonry

Masonry frames

Cut: 310 x 130 mm

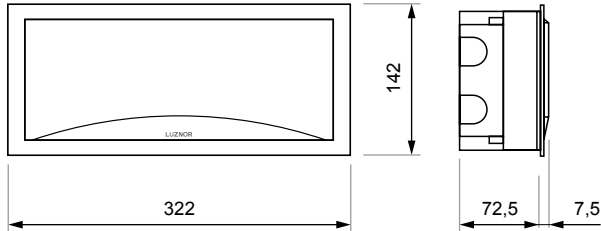

Ref. CE-G
RRP. 11.02 €

Signs and pictograms



Ref. R12
260 x 120 mm
RRP. 2.54 €



Ref. R13
260 x 120 mm
RRP. 2.54 €



Ref. R14
260 x 120 mm
RRP. 2.54 €



Ref. R15
260 x 120 mm
RRP. 2.54 €



Ref. R16
260 x 120 mm
RRP. 2.54 €



Ref. P7
260 x 120 mm
RRP. 2.54 €



Ref. P8
260 x 120 mm
RRP. 2.54 €



Ref. P9
260 x 120 mm
RRP. 2.54 €

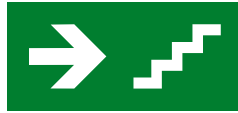

Ref. P10
260 x 120 mm
RRP. 2.54 €



Ref. P11
260 x 120 mm
RRP. 2.54 €



Ref. P12
260 x 120 mm
RRP. 2.54 €





L Led Series

The timeless design emergency luminaire. LED strip lighting (colour temperature: 5,000 K) with internal diffuser, improving the energy efficiency and the aesthetic and functional value of the classic L series. Choice of maintained or non-maintained mode. Special model with 1,200 lumens non-maintained (colour temperature: 5,700 K). Remote controllable.



Maintained / Non-maintained

model	Φ (lm)	A (h)	P net (W)	RRP (€)
LL-110P-TT	118	1	4.3 / 3.0	53.09
LL-230P-TT	235	1	5.1 / 3.0	57.83
LL-350P-TT	353	1	5.8 / 3.0	66.02
LL-470P-TT	470	1	7.1 / 3.0	77.72
LL-580P-TT	588	1	8.4 / 3.1	89.14
LL-110P-2-TT	118	2	4.3 / 3.0	59.72
LL-170P-2-TT	176	2	5.1 / 3.0	68.14
LL-230P-2-TT	235	2	5.1 / 3.0	75.16
LL-290P-2-TT	294	2	5.8 / 3.0	86.91
LL-70P-3-TT	78	3	4.3 / 3.0	59.72
LL-110P-3-TT	118	3	4.3 / 3.0	62.24
LL-150P-3-TT	157	3	5.1 / 3.0	75.16
LL-190P-3-TT	196	3	5.1 / 3.0	81.13

To request a different internal and external diffuser type, change the corresponding letters in the reference. Example:

LL-470P-TS

Internal diffuser	T Transparent
External diffuser	S Soft opal (-8%)
	F Strong opal (-30%)

- ◇ Internal diffuser: allows for optimum protection of the LEDs and homogeneous illumination.
- ◇ Protection rating: IP42.
- ◇ Ni-Cd (HT) battery except for the special model LL-1200, with Li-Ion battery.
- ◇ Accessories and signalling on page 34.

Special model 1,200 lm NM

model	Φ (lm)	A (h)	P net (W)	RRP (€)
LL-1200-TT	1.200	1	3.0	136.39

Surface mounting





L Basic Led Series

The basic version of the L Led series. LED strip lighting (colour temperature: 5,700 K) with internal diffuser. It maintains the timeless design of the classic L series with softened edges and the same quality and resistance as always, but with improved performance and maximum energy efficiency in its more affordable version.



Non-maintained

model	Φ (lm)	A (h)	P net (W)	RRP (€)
LL-100-T	100	1	1.5	23.63
LL-150-T	150	1	1.5	26.31
LL-200-T	200	1	1.5	32.93
LL-250-T	250	1	2.6	36.58
LL-300-T	300	1	2.6	37.20
LL-350-T	350	1	2.6	37.77
LL-400-T	400	1	2.6	39.79
LL-450-T	450	1	2.6	40.29
LL-100-2-T	100	2	1.5	33.17
LL-150-2-T	150	2	2.6	35.50
LL-200-2-T	200	2	2.6	37.55
LL-250-2-T	250	2	2.6	38.09
LL-100-3-T	100	3	2.6	34.96
LL-150-3-T	150	3	2.6	37.01

Maintained

model	Φ (lm)	A (h)	P net (W)	RRP (€)
LL-100B-T	100	1	2.8	39.76
LL-150B-T	150	1	3.3	40.61
LL-200B-T	200	1	3.9	46.78
LL-250B-T	250	1	5.4	51.01
LL-300B-T	300	1	5.9	51.48
LL-350B-T	350	1	6.4	51.97
LL-400B-T	400	1	6.9	52.43
LL-450B-T	450	1	7.5	52.90
LL-100B-2-T	100	2	2.8	46.81
LL-150B-2-T	150	2	4.4	50.10
LL-200B-2-T	200	2	4.9	50.57
LL-250B-2-T	250	2	5.4	51.01
LL-100B-3-T	100	3	3.8	49.65
LL-150B-3-T	150	3	4.4	50.10

Centralizable luminaires

model	Φ (lm)	power supply	P net (W)	RRP (€)
LL-100L-S	100	85±265 Vac and 120±370 Vdc	1.3	34.29
LL-200L-S	200	85±265 Vac and 120±370 Vdc	2.4	37.29
LL-300L-S	300	85±265 Vac and 120±370 Vdc	3.3	39.53
LL-450L-S	450	85±265 Vac and 120±370 Vdc	4.9	43.93

To request a different diffuser type, change the corresponding letter in the reference. Example:

LL-250-2-F
 Diffuser | T Transparent
 S Soft opal (-8%)
 F Strong opal (-30%)

Surface mounting

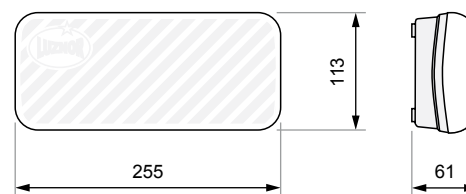

- ◇ Protection rating: IP42.
- ◇ Ni-Cd (HT) battery.
- ◇ Accessories and signalling on page 34.



Serie L Basic Led AUTOTEST

The basic version of the L Led series with Autotest function: a microprocessor checks the status of the emergency LEDs, the battery and the electronics periodically. Illumination by LED strip (colour temperature: 5,700 K) with maximum energy efficiency, without internal diffuser. Remote controllable.



Non-maintained

model	Φ (lm)	A (h)	P net (W)	RRP (€)
LLA-100-T	100	1	1.5	51.46
LLA-150-T	150	1	1.5	54.13
LLA-200-T	200	1	1.5	60.75
LLA-250-T	250	1	2.6	64.40
LLA-300-T	300	1	2.6	65.03
LLA-350-T	350	1	2.6	65.60
LLA-400-T	400	1	2.6	67.62
LLA-450-T	450	1	2.6	68.12
LLA-100-2-T	100	2	1.5	61.00
LLA-150-2-T	150	2	2.6	63.32
LLA-200-2-T	200	2	2.6	65.37
LLA-250-2-T	250	2	2.6	65.91
LLA-100-3-T	100	3	2.6	62.78
LLA-150-3-T	150	3	2.6	64.83

Maintained

model	Φ (lm)	A (h)	P net (W)	RRP (€)
LLA-100B-T	100	1	2.8	67.59
LLA-150B-T	150	1	3.3	68.43
LLA-200B-T	200	1	3.9	74.60
LLA-250B-T	250	1	5.4	78.84
LLA-300B-T	300	1	5.9	79.31
LLA-350B-T	350	1	6.4	79.79
LLA-400B-T	400	1	6.9	80.25
LLA-450B-T	450	1	7.5	80.72
LLA-100B-2-T	100	2	2.8	74.63
LLA-150B-2-T	150	2	4.4	77.93
LLA-200B-2-T	200	2	4.9	78.40
LLA-250B-2-T	250	2	5.4	78.84
LLA-100B-3-T	100	3	3.8	77.48
LLA-150B-3-T	150	3	4.4	77.93

To request a different diffuser type, change the corresponding letter in the reference. Example:

LLA-200-2-S
 ↳ Diffuser | T Transparent
 | S Soft opal (-8%)
 | F Strong opal (-30%)

- ◇ Protection rating: IP42.
- ◇ Ni-Cd (HT) battery.
- ◇ Information about Autotest on page 87.
- ◇ Accessories and signalling on page 34.

Surface mounting

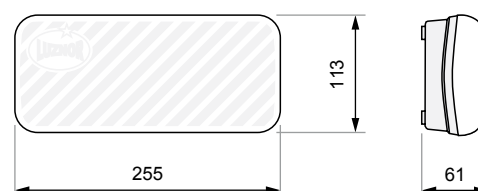

L (Basic) Led Series ACCESSORIES AND SIGNALLING

Recessed mounting

Frames for recessed mounting in hollow surface



White
Ref. ML-B
RRP. 5.26 €



Matt chrome
Ref. ML-C
RRP. 11.70 €



Graphite
Ref. ML-G
RRP. 11.70 €



Anthracite
Ref. ML-A
RRP. 5.26 €

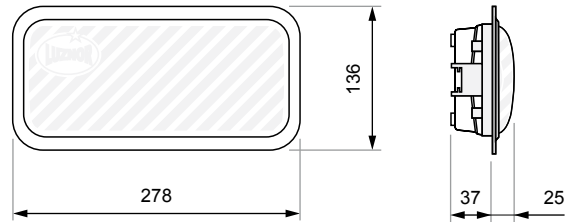

Cut: 265 x 120 mm

Flush mounting

Flush box in hollow surface

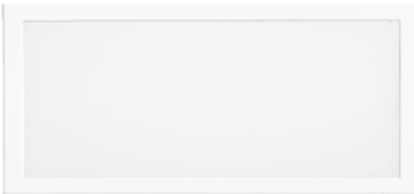

White
Ref. MDP-BO
RRP. 16.16 €



Matt chrome
Ref. MDP-CO
RRP. 21.73 €

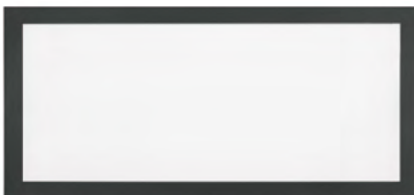

Anthracite
Ref. MDP-AO
RRP. 17.38 €

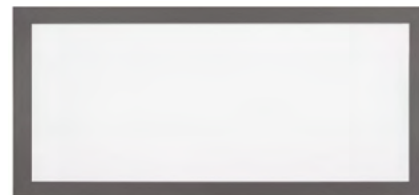

Graphite
Ref. MDP-GO
RRP. 21.73 €

Cut: 300 x 127 mm

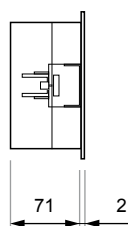
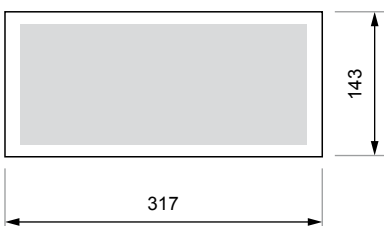
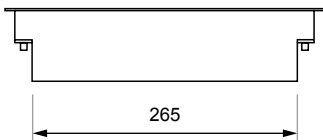

Flush mounting in masonry

Masonry box

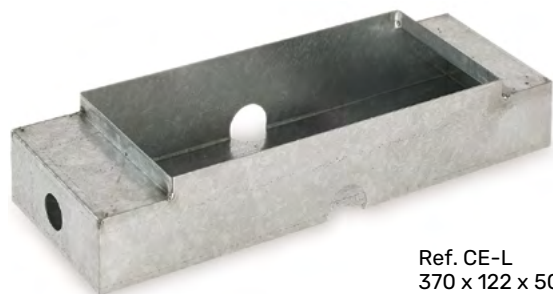

Ref. CE-L
370 x 122 x 50 mm
RRP. 13.99 €

L (Basic) Led Series ACCESSORIES AND SIGNALLING

Flush mounting with banner

Flush box in hollow surface incl. transparent banner



- White
Ref. MDP-B-B0
RRP. 29.09 €
- Anthracite
Ref. MDP-B-A0
RRP. 30.31 €
- Graphite
Ref. MDP-B-G0
RRP. 34.66 €
- Matt chrome
Ref. MDP-B-C0
RRP. 34.66 €

Watertight mounting

IP67 watertight box

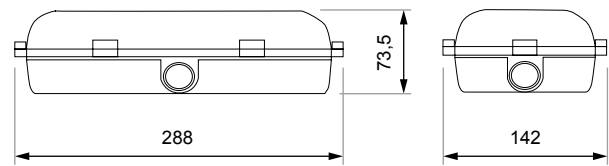

Ref. BE-L
RRP. 26.58 €

Ceiling banner

Includes special diffuser for attaching the banner.



Ref. BL-T
RRP. 26.42 €

Wall banner

Includes special diffuser for attaching the banner.



Ref. BL-P
RRP. 26.42 €

Protection grill

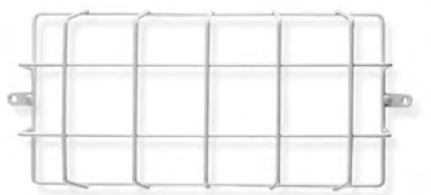

Ref. RJ
412 x 182 mm
RRP. 50.53 €

Oval diffuser frame



Ref. MDO-B0
RRP. 16.16 €

Signs and pictograms



Ref. R1
200 x 50 mm
RRP. 2.75 €



Ref. R2
200 x 50 mm
RRP. 2.75 €



Ref. R3
200 x 100 mm
RRP. 2.75 €



Ref. R4
200 x 100 mm
RRP. 2.75 €



Ref. R5
200 x 100 mm
RRP. 2.75 €



Ref. R8
200 x 100 mm
RRP. 2.75 €



Ref. R11
200 x 100 mm
RRP. 2.75 €



Ref. P1
300 x 100 mm
RRP. 2.75 €



Ref. P2
200 x 100 mm
RRP. 2.75 €



Ref. P3
200 x 100 mm
RRP. 2.75 €



Serie LLD

Basic flush-mounted LED emergency luminaire, flat aesthetics and rectangular shape with sharp edges. The LLD series is an emergency luminaire of the L Basic Led series inside an MDP flush box. Fully covering opal diffuser for a minimalist finish and homogeneous and discreet illumination. Remote controllable.



Non-maintained

model	Φ (lm)	A (h)	P net (W)	RRP (€)
LLD-100-B0	100	1	1.5	39.80
LLD-150-B0	150	1	1.5	42.46
LLD-200-B0	200	1	1.5	49.08
LLD-250-B0	250	1	2.6	52.73
LLD-300-B0	300	1	2.6	53.36
LLD-350-B0	350	1	2.6	53.94
LLD-400-B0	400	1	2.6	55.95
LLD-450-B0	450	1	2.6	56.46
LLD-100-2-B0	100	2	1.5	49.33
LLD-150-2-B0	150	2	2.6	51.65
LLD-200-2-B0	200	2	2.6	53.71
LLD-250-2-B0	250	2	2.6	54.24
LLD-100-3-B0	100	3	2.6	51.12
LLD-150-3-B0	150	3	2.6	53.16

Maintained

model	Φ (lm)	A (h)	P net (W)	RRP (€)
LLD-100B-B0	100	1	2.8	55.92
LLD-150B-B0	150	1	3.3	56.76
LLD-200B-B0	200	1	3.9	62.94
LLD-250B-B0	250	1	5.4	67.18
LLD-300B-B0	300	1	5.9	67.65
LLD-350B-B0	350	1	6.4	68.13
LLD-400B-B0	400	1	6.9	68.58
LLD-450B-B0	450	1	7.5	69.05
LLD-100B-2-B0	100	2	2.8	62.96
LLD-150B-2-B0	150	2	4.4	66.26
LLD-200B-2-B0	200	2	4.9	66.74
LLD-250B-2-B0	250	2	5.4	67.18
LLD-100B-3-B0	100	3	3.8	65.81
LLD-150B-3-B0	150	3	4.4	66.26

Centralizable luminaires

model	Φ (lm)	power supply	RRP (€)
LLD-100L-B0	100	85÷265 Vac and 120÷370 Vdc	50.46
LLD-200L-B0	200	85÷265 Vac and 120÷370 Vdc	53.46
LLD-300L-B0	300	85÷265 Vac and 120÷370 Vdc	55.68
LLD-450L-B0	450	85÷265 Vac and 120÷370 Vdc	60.10

To request different finish of the flush box frame, change the corresponding letter in the reference. Example:

LLD-400-A0	Body	B White
		A Anthracite (+1.22 €)
		G Graphite (+5.57 €)
		C Matt chrome (+5.57 €)

◇ Protection rating: IP42.

◇ Ni-Cd (HT) battery.

Flush mounting

Cut: 300 x 127 mm

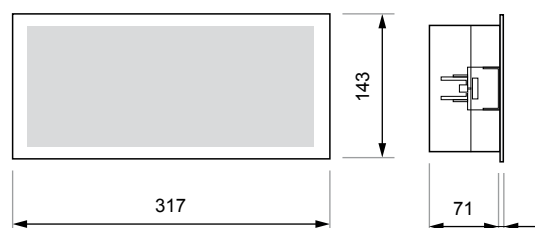
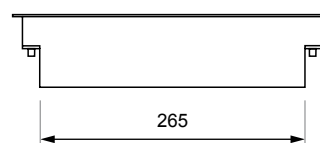

◇ Finishes, accessories and signalling on page 40.



Serie LLE

Basic watertight LED emergency luminaire. The LLE series is an emergency of the L Basic Led series (medium power LED plate lighting) in a BE-L (IP67) watertight housing for surface installation. Transparent diffuser as standard, with the option of adding a second soft or strong opal diffuser. Remote controllable.



Non-maintained

model	Φ (lm)	A (h)	P net (W)	RRP (€)
LLE-100	100	1	1.5	50.21
LLE-150	150	1	1.5	52.89
LLE-200	200	1	1.5	59.51
LLE-250	250	1	2.6	63.16
LLE-300	300	1	2.6	63.78
LLE-350	350	1	2.6	64.35
LLE-400	400	1	2.6	66.37
LLE-450	450	1	2.6	66.87
LLE-100-2	100	2	1.5	59.75
LLE-150-2	150	2	2.6	62.08
LLE-200-2	200	2	2.6	64.13
LLE-250-2	250	2	2.6	64.67
LLE-100-3	100	3	2.6	61.54
LLE-150-3	150	3	2.6	63.59

Maintained

model	Φ (lm)	A (h)	P net (W)	RRP (€)
LLE-100B	100	1	2.8	66.34
LLE-150B	150	1	3.3	67.19
LLE-200B	200	1	3.9	73.37
LLE-250B	250	1	5.4	77.59
LLE-300B	300	1	5.9	78.06
LLE-350B	350	1	6.4	78.55
LLE-400B	400	1	6.9	79.01
LLE-450B	450	1	7.5	79.48
LLE-100B-2	100	2	2.8	73.39
LLE-150B-2	150	2	4.4	76.68
LLE-200B-2	200	2	4.9	77.15
LLE-250B-2	250	2	5.4	77.59
LLE-100B-3	100	3	3.8	76.23
LLE-150B-3	150	3	4.4	76.68

Centralizable luminaires

model	Φ (lm)	power supply	RRP (€)
LLE-100L-S	100	85÷265 Vac and 120÷370 Vdc	53.27
LLE-200L-S	200	85÷265 Vac and 120÷370 Vdc	56.27
LLE-300L-S	300	85÷265 Vac and 120÷370 Vdc	58.50
LLE-450L-S	450	85÷265 Vac and 120÷370 Vdc	62.91

To request the addition of a second soft or strong opal diffuser, add "-S" or "-F" to the reference respectively. Example:

LLE-450B-S

└─ Extra diffuser | **S** Soft opal (-8%)
F Strong opal (-30%)

Surface mounting

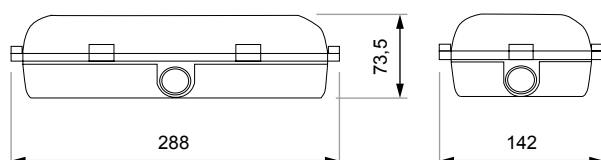

◇ Protection rating: IP67.

◇ Ni-Cd (HT) battery.

◇ Accessories on page 41.

◇ Supplied with three cable gland entries for cable glands size PG 13.5 and two plugs with sealing gaskets

LLD Series FINISHES, ACCESSORIES AND SIGNALLING

Flush box finishes

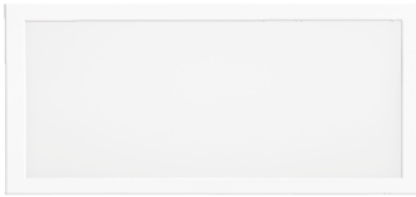

White
Ref. B0



Matt chrome
Ref. C0



Anthracite
Ref. A0

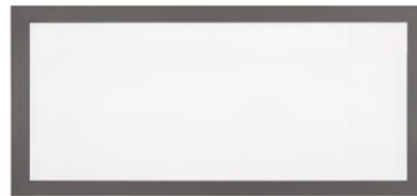

Graphite
Ref. G0

Signs and pictograms



Ref. R6
270 x 100 mm
RRP. 2.75 €



Ref. R7
270 x 135 mm
RRP. 2.75 €



Ref. R9
270 x 100 mm
RRP. 2.75 €



Ref. R10
270 x 100 mm
RRP. 2.75 €

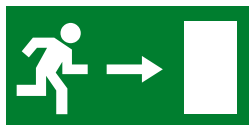

Ref. P4
270 x 135 mm
RRP. 2.75 €

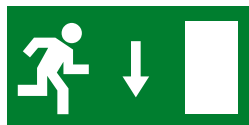

Ref. P5
270 x 135 mm
RRP. 2.75 €



Ref. P6
270 x 135 mm
RRP. 2.75 €

Ceiling banner

Transparent banner with special diffuser for anchoring.



Ref. BMDP-T0
RRP. 17.38 €

Flush mounting in masonry

Masonry box



Ref. CE-MDP
420 x 128 x 71 mm
RRP. 17.78 €



LLE Series ACCESSORIES

Recessed mounting

Stainless steel frame for BE-L watertight box

Cut: 300 x 160 mm



Ref. MBEL-I
386 x 196 mm
RRP. 25.54 €

Swivel mounting

Epoxy painted grey RAL 7035 steel orientation kit for BE-L watertight box



Ref. COBEL
RRP. 18.98 €

Remote control ANY REMOTE CONTROLLABLE SERIES

◇ The remote control allows all remote controllable series, whether emergency luminaires, beacon lights or centralizing devices, to be switched off and on again in the absence of mains power.

◇ Can be mounted on a M36 DIN rail (4 modules).

model	A (h)	capacity	dimensions	battery	RRP (€)
TL-300	1	300 devices	70 x 90 x 58 mm	Ni-MH	101.82

Installation scheme

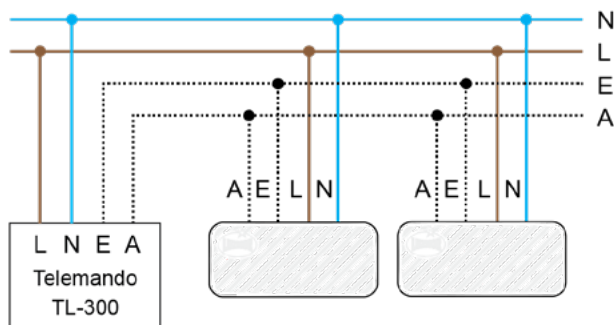

Signalling PHOTOLUMINISCENT



Ref. PF2101
200 x 100 mm
RRP. 10.16 €



Ref. PF2102
200 x 100 mm
RRP. 10.16 €



Ref. PF2103
200 x 100 mm
RRP. 10.16 €



Ref. PF2104
200 x 100 mm
RRP. 10.16 €



Ref. PF2105
200 x 100 mm
RRP. 10.16 €



Ref. PF2106
200 x 100 mm
RRP. 10.16 €



Ref. PF2109
200 x 100 mm
RRP. 10.16 €



Ref. PF2110
200 x 100 mm
RRP. 10.16 €



Ref. PF2111
200 x 100 mm
RRP. 10.16 €



Ref. PF2112
200 x 100 mm
RRP. 10.16 €

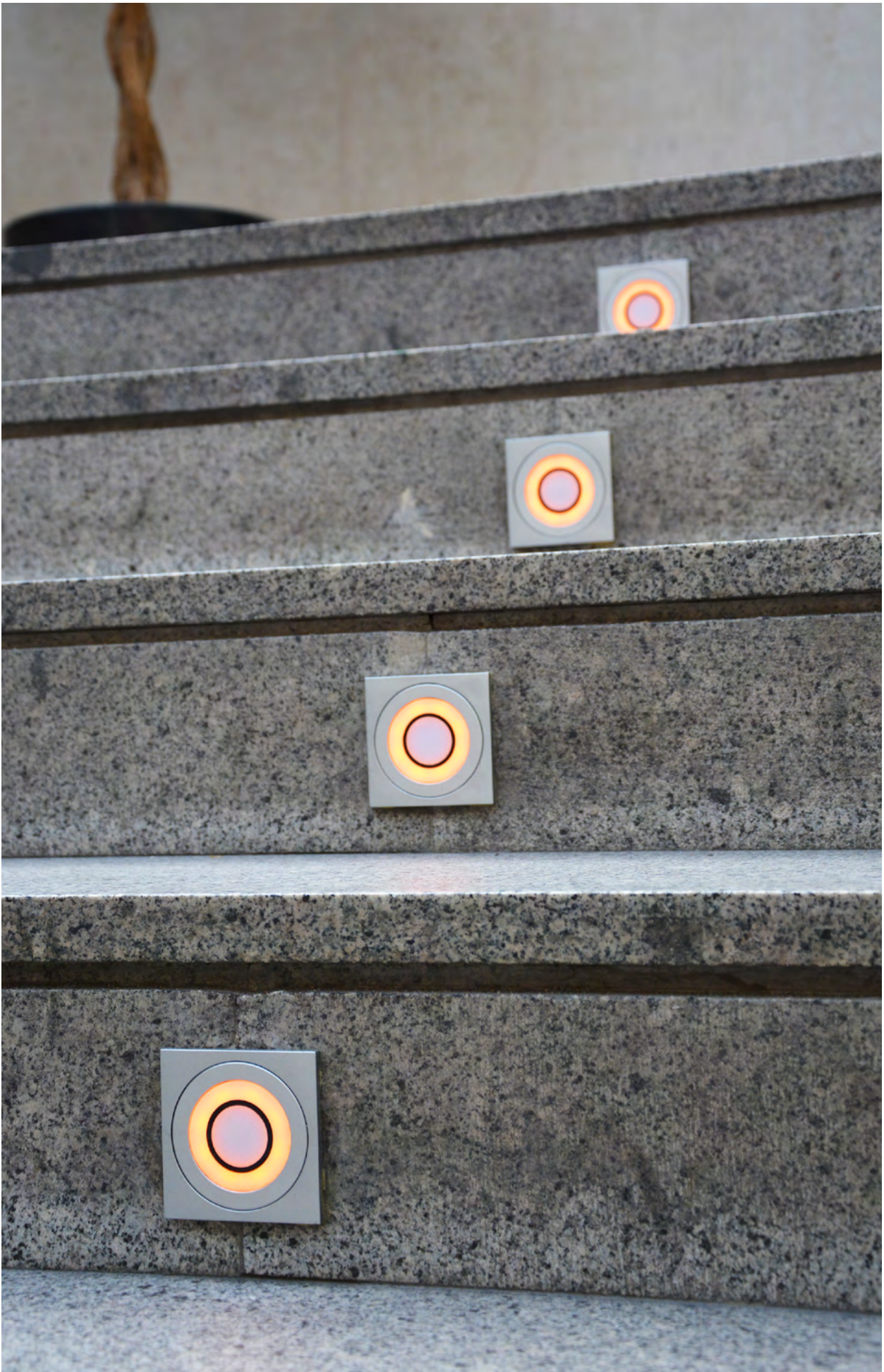

Matiz Serie SELF-CONTAINED

Self-contained beacon light, small in size and carefully designed. Composed of a central white LED and an ambient or corporative LED crown in different colours. Choice of: maintained mode (white central LED on in addition to the crown) or non-maintained (white central LED only for emergency lighting).



Matiz in maintained mode: in addition to the ambient LED crown in the desired colour, the central white LED is permanently lit. In emergency mode, the ambient LED crown is switched off and the central LED lights up brightly.

Maintained and non-maintained

model	A (h)	RRP (€)
MA-BB	1 or 2 (recharge in 24 or 48 h)	39.47

To request different finish of the body and/or different colour of the ambient LED crown, change the corresponding letters in the reference. To request IP55 protection rating, add the letter "E" to the reference. Example:

Colour LEDs	B <input type="checkbox"/> Y <input type="checkbox"/> V <input type="checkbox"/> A <input type="checkbox"/> R <input type="checkbox"/>
Protection	IP42 E IP55 (+10.71 €)
Body	B White A Anthracite (+0.54 €) G Graphite (+4.29 €) C Matt chrome (+4.29 €)

Surface mounting

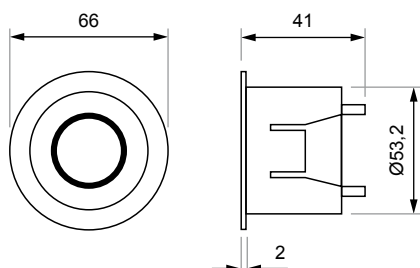

◇ Finishes and accessories on page 49.

Technical characteristics

◇ Power supply	230 Vac
◇ Consumption	0.5 W
◇ Electrical insulation	Class II
◇ Remote controllable	No
◇ Protection rating	IP42 or IP55, IK08

Installation scheme

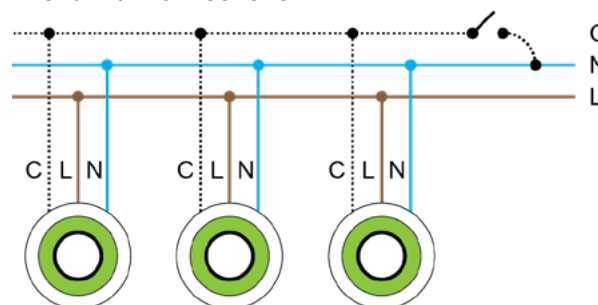

Control line C is used to control the switching on and off of the central LED in the presence of mains power (maintained or non-maintained mode).

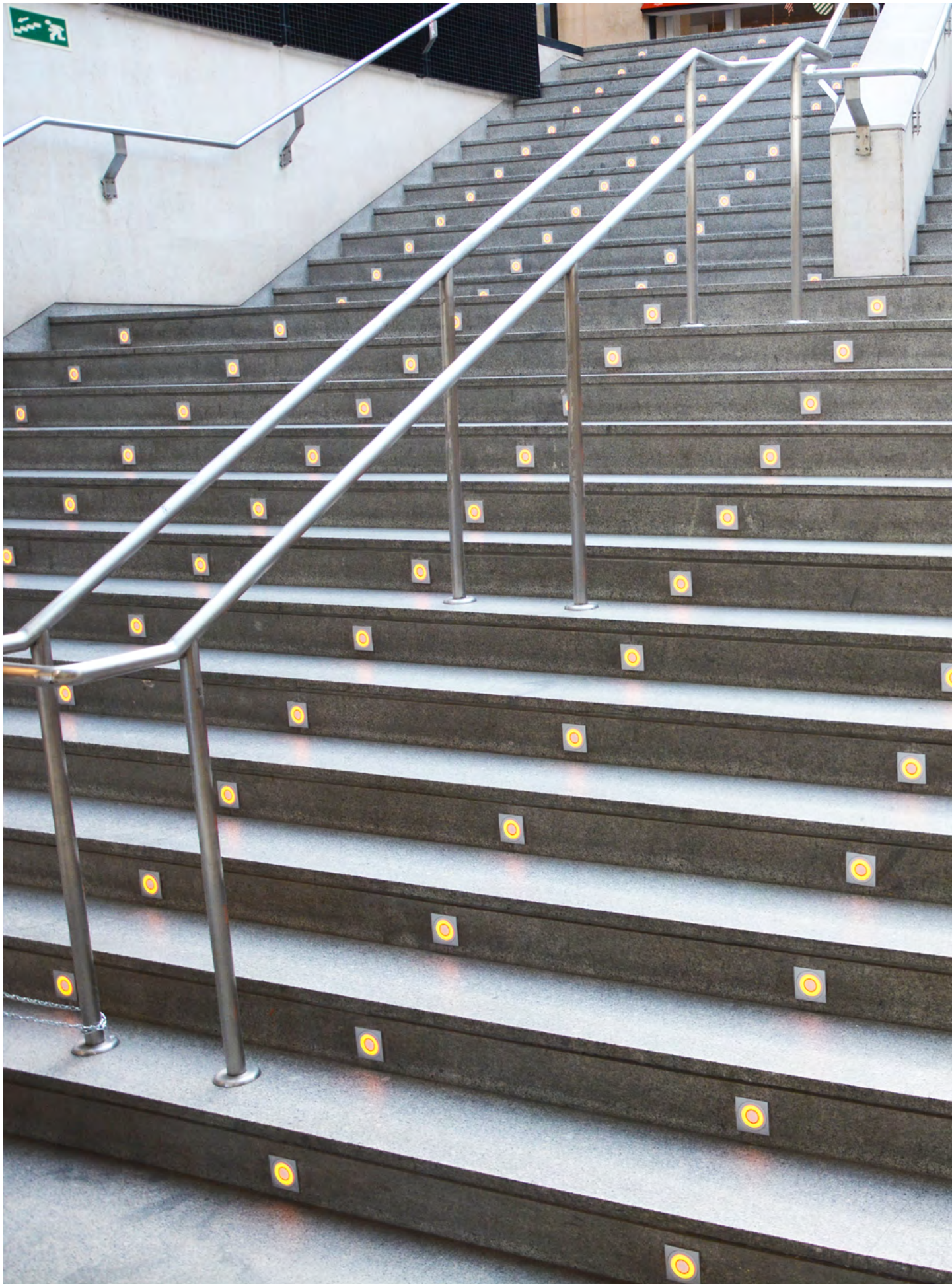



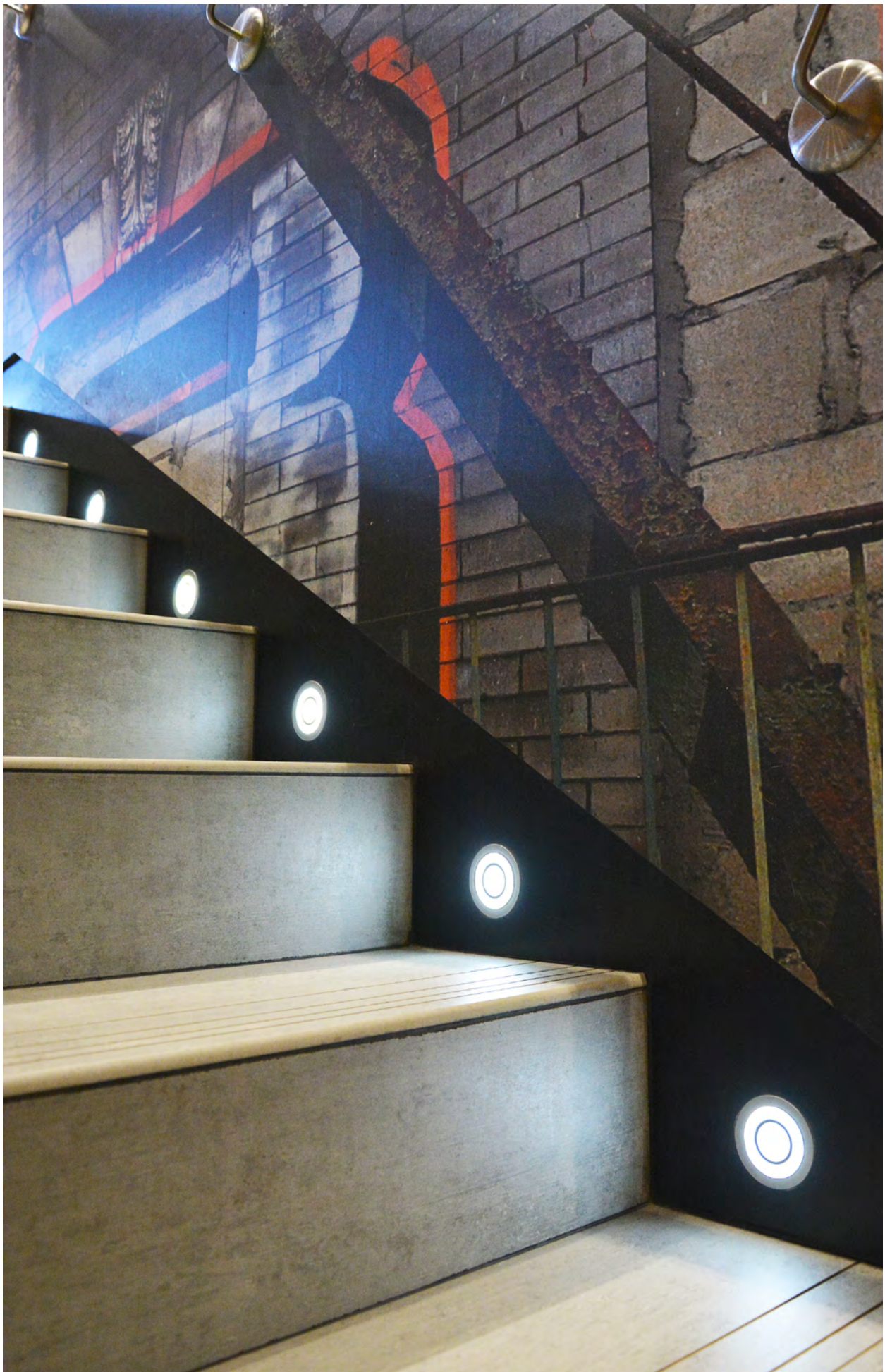

Matiz Series CENTRALIZED

Centralized beacon light, small in size and carefully designed. Composed by a white central LED and an ambient LED crown of different colours. Choice of: maintained mode (white central LED on in addition to the crown) or non-maintained mode (white central LED only for emergency lighting).



Matiz in non-maintained mode: the ambient LED crown remains on but the central white LED is permanently off. In emergency mode, the ambient LED crown is switched off and the central LED lights up brightly.

Maintained / Non-maintained

model	power supply	RRP (€)
MC-BB	24 or 12 Vdc	33.08

To request a different body finish and/or different colour of the ambient LED crown, change the corresponding letters in the reference. To request IP55 protection rating, add the letter "E" to the reference. Example:

MC-GBE	Colour LEDs	B <input type="checkbox"/> Y <input type="checkbox"/> V <input type="checkbox"/> A <input type="checkbox"/> R <input type="checkbox"/>
	Protection	IP42 E IP55 (+10.71 €)
	Body	B White A Anthracite (+0.54 €) G Graphite (+4.29 €) C Matt chrome (+4.29 €)

Technical characteristics

- ◇ Electrical insulation Class III
- ◇ Remote controllable Yes (centralizing device)
- ◇ Protection rating IP42 or IP55, IK08
- ◇ Finishes and accessories on page 49.

Surface mounting

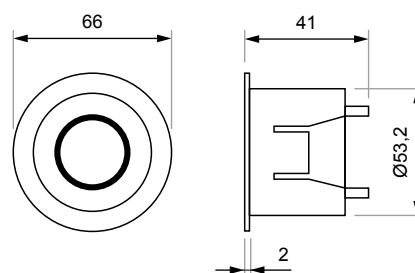

Installation scheme

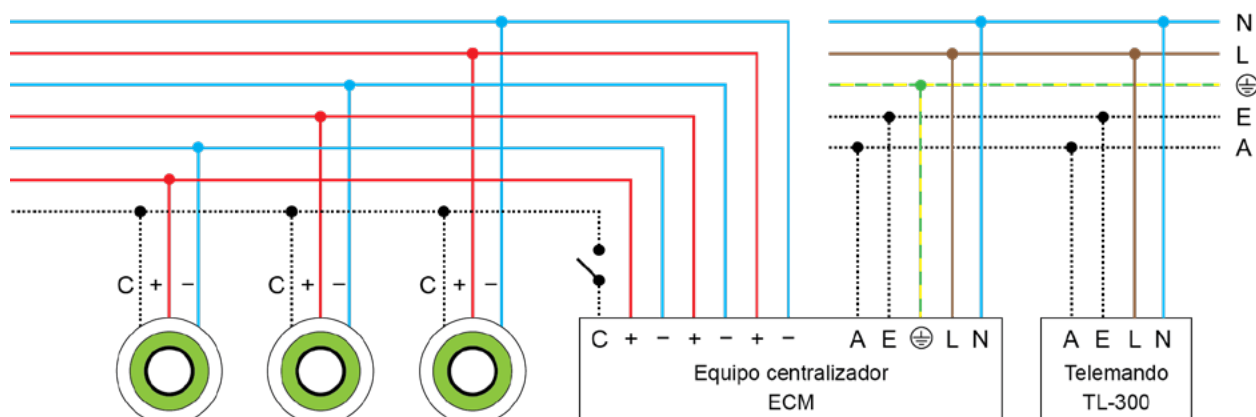

Matiz Series CENTRALIZED

Centralizing devices

- ◊ The centralizing device powers the beacon lights at 24 Vdc in presence of mains (maintained) and at 12 Vdc in emergency mode.
- ◊ Metal wall mounting cabinet with front door.
- ◊ Epoxy paint grey colour RAL 7035.
- ◊ With remote control input.
- ◊ Ni-Cd (HT) battery.
- ◊ Each team can power a maximum number of beacon lights, ensuring a 1 hour emergency autonomy.

model	A (h)	beacons	dimensions (mm)	RRP (€)
ECM-60	1	60	400 x 300 x 150	525.40
ECM-160	1	160	400 x 300 x 150	629.52
ECM-280	1	280	400 x 300 x 150	839.66
ECM-560	1	560	500 x 400 x 200	1,440.68



Matiz Series FINISHES AND ACCESSORIES

Body finish



White



Anthracite



Matt chrome



Graphite

Flush mounting

Flush frames for universal round or square boxes



White
Ref. MMU-B
RRP. 3.73 €



Anthracite
Ref. MMU-A
RRP. 4.27 €

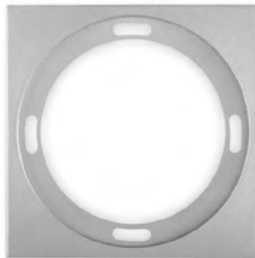

Matt chrome
Ref. MMU-C
RRP. 8.02 €

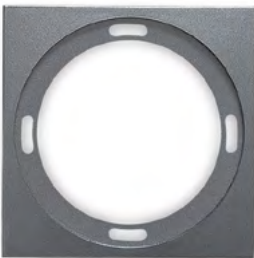

Graphite
Ref. MMU-G
RRP. 8.02 €

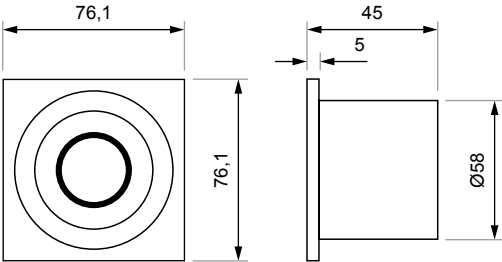

Spring kit



Ref. MS-MA
RRP. 4.16 €

Flush mounting in masonry

Masonry box

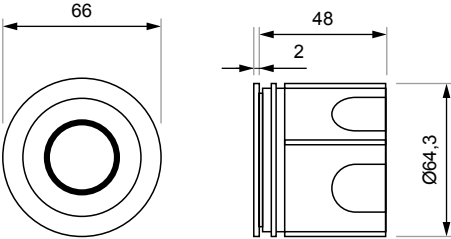

Ref. CE-MA
RRP. 4.80 €



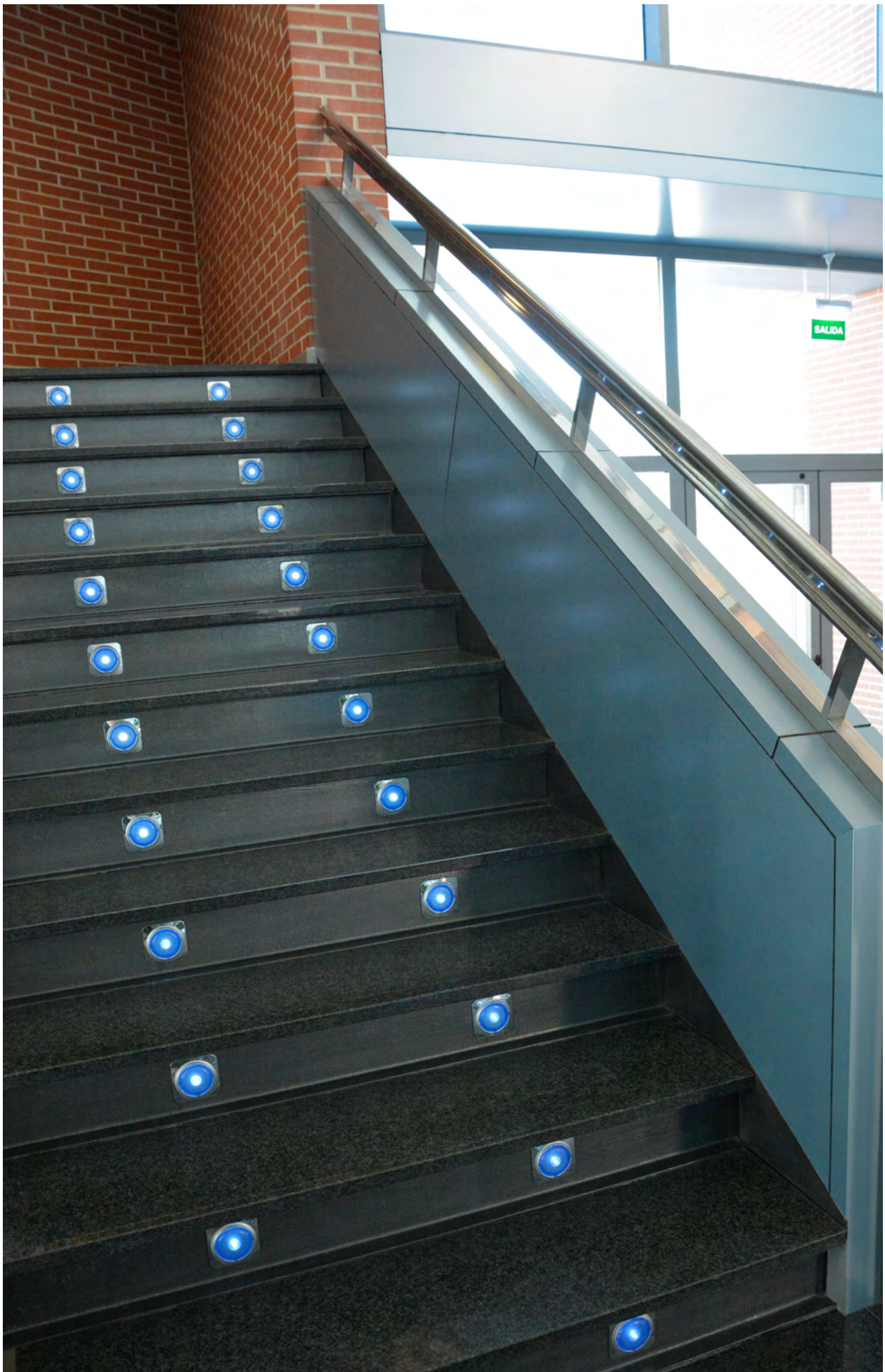

Élite Series SELF-CONTAINED

Classic beacon light with a timeless design and high resistance. Consisting of a central white LED and polycarbonate diffuser available in different colours. Self-contained (Ni-MH HT battery) and maintained mode functioning. Ideal size for installation in round or square universal box.



Maintained

model	A (h)	RRP (€)
PA-BT	2 or 4 (recharge in 24 or 48 h)	24.36

Maintained remote controllable

model	A (h)	RRP (€)
PT-BT	2 or 4 (recharge in 24 or 48 h)	31.73

Technical characteristics

- ◇ Power supply 230 Vac
- ◇ Consumption 0.5 W
- ◇ Electrical insulation Class II
- ◇ Remote controllable Yes
- ◇ Protection rating IP42 or IP55, IK08
- ◇ Finishes and accessories on page 54.

To request different body finish and/or different diffuser colour, change the corresponding letters in the reference. To request IP55 protection rating, add the letter "E" to the reference. Example:

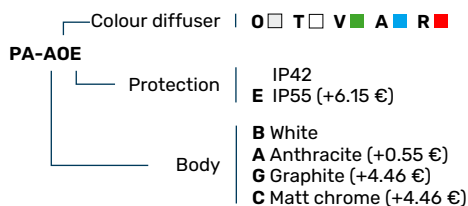

Surface mounting

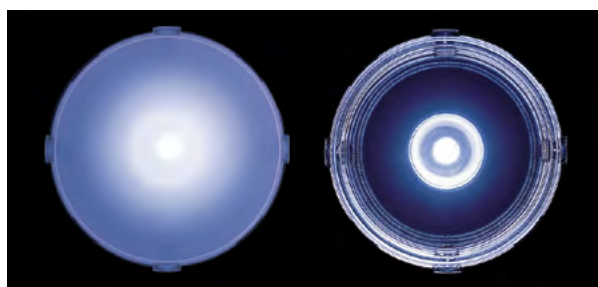
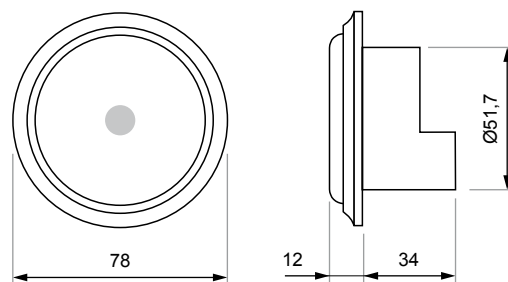

Élite beacon light with opal or transparent diffuser.

Installation scheme

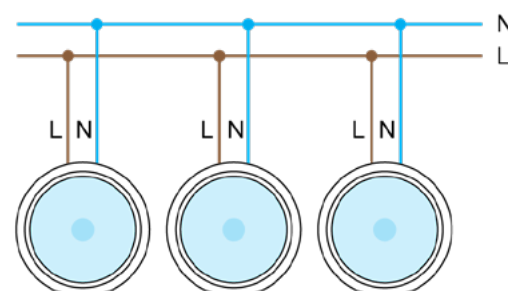

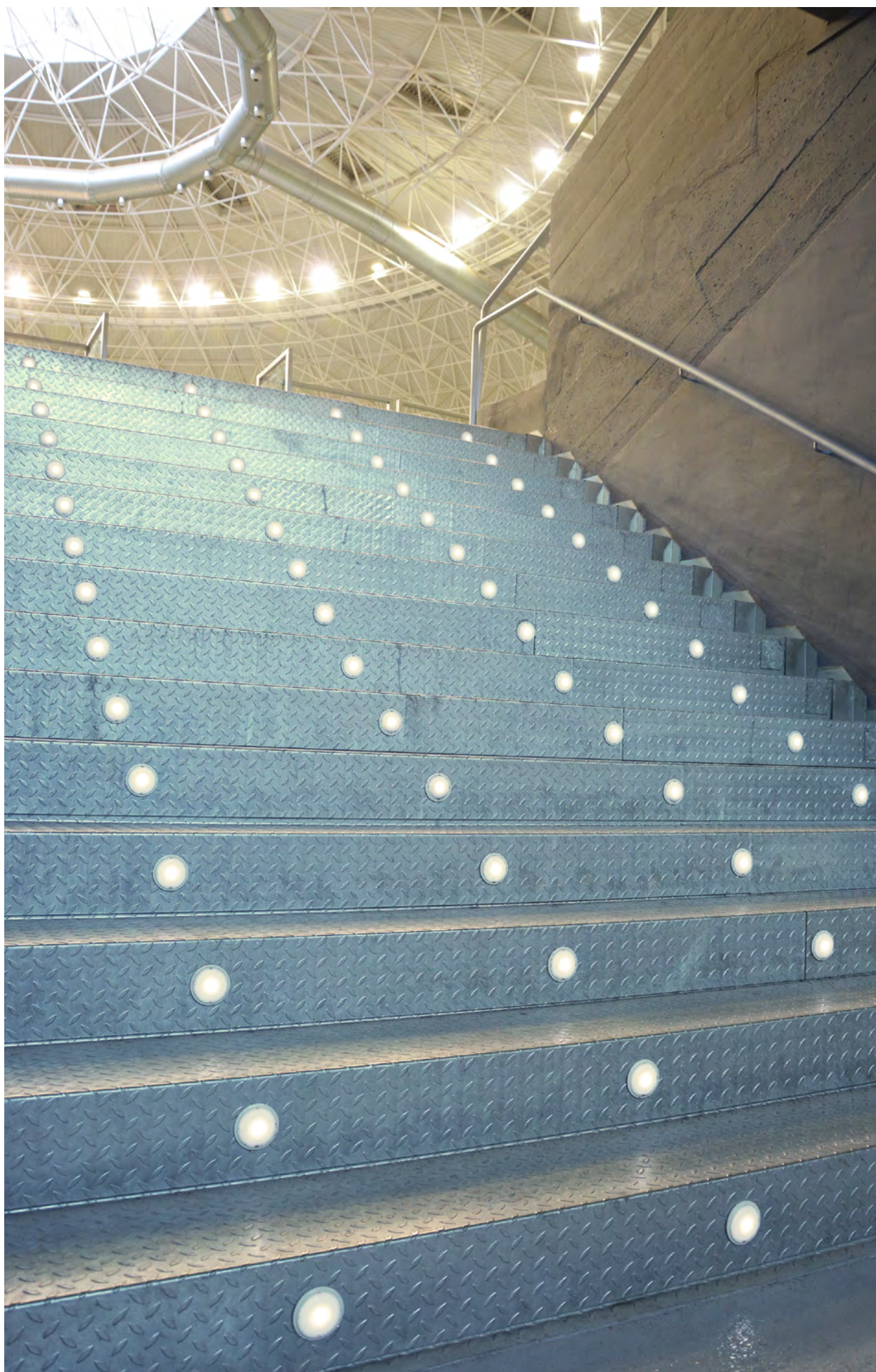

Élite Series CENTRALIZED

Classic beacon light with a timeless design and high resistance. Consisting of a central white LED and polycarbonate diffuser available in various colours. Centralized (powered by a centralizing device) and maintained functioning mode. To be installed in round or square universal box.



Maintained

model	power supply	RRP (€)
PC-BT	6 Vdc	12.01

To request different body finish and/or different diffuser colour, change the corresponding letters in the reference. To request IP55 protection rating, add the letter "E" to the reference. Example:

Diffuser colour		<input type="checkbox"/> O	<input type="checkbox"/> T	<input type="checkbox"/> V	<input type="checkbox"/> G	<input type="checkbox"/> A	<input type="checkbox"/> R
Protection		IP42					
		E IP55 (+2.97 €)					
Body		B White					
		A Anthracite (+0.55 €)					
		G Graphite (+4.46 €)					
		C Matt chrome (+4.46 €)					

Technical characteristics

- ◇ Electrical insulation Class III
- ◇ Remote controllable (centralising device)
- ◇ Protection rating IP42 or IP55, IK08
- ◇ Finishes and accessories on page 54.

Surface mounting

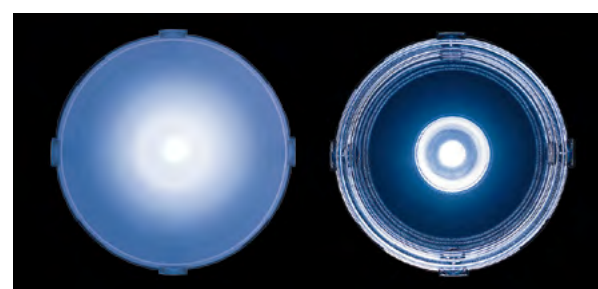
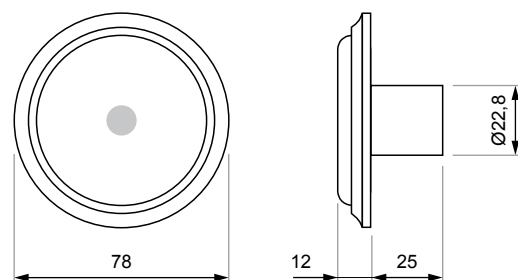

Élite beacon light with opal or transparent diffuser.

Installation scheme

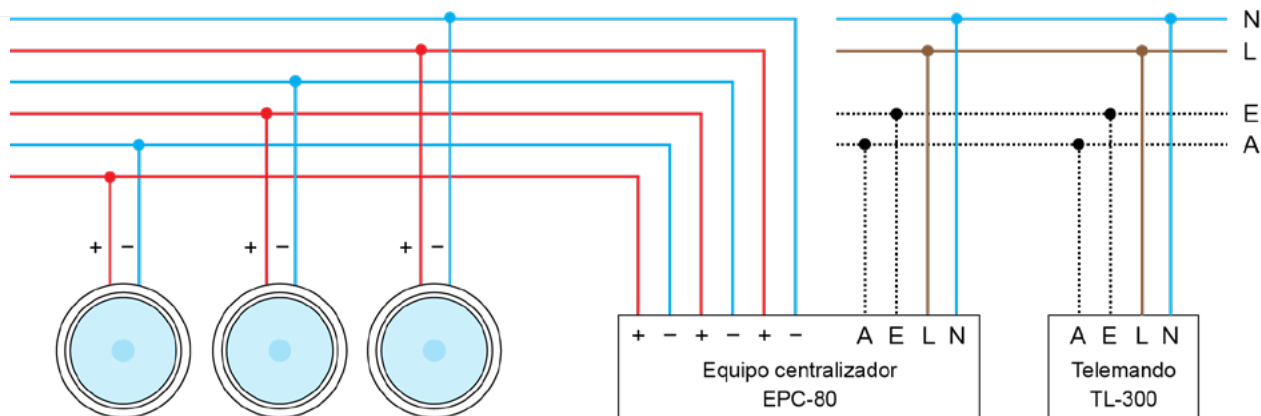

Élite Series CENTRALIZED

Centralizing device

- ◊ The centralizing device powers the beacons at 6 Vdc, both in the presence of the mains (maintained) and in emergency mode.
- ◊ It can power a maximum of 80 beacons ensuring a 1 hour autonomy in emergency mode.
- ◊ With remote control input.
- ◊ Ni-Cd (HT) battery.
- ◊ Can be mounted on a M36 DIN rail (9 modules).



model	A (h)	beacons	dimensions (mm)	RRP (€)
EPC-80	1	80	158 x 90 x 58	174.47

Élite Series FINISHED AND ACCESSORIES

Body finish



White



Anthracite



Matt chrome



Graphite

Flush mounting

Flush frames for round and square universal box



White
Ref. MP-B
RRP. 1.85 €



Anthracite
Ref. MP-A
RRP. 2.40 €



Matt chrome
Ref. MP-C
RRP. 6.30 €



Graphite
Ref. MP-G
RRP. 6.30 €

Élite self-contained

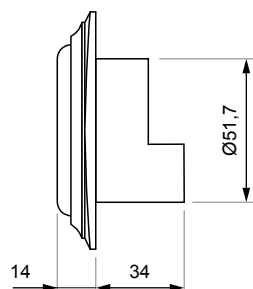
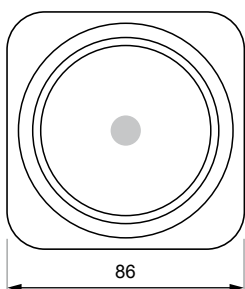

Élite centralized

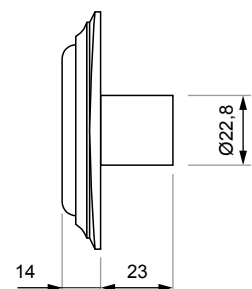
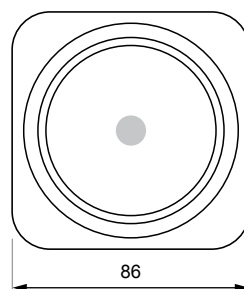



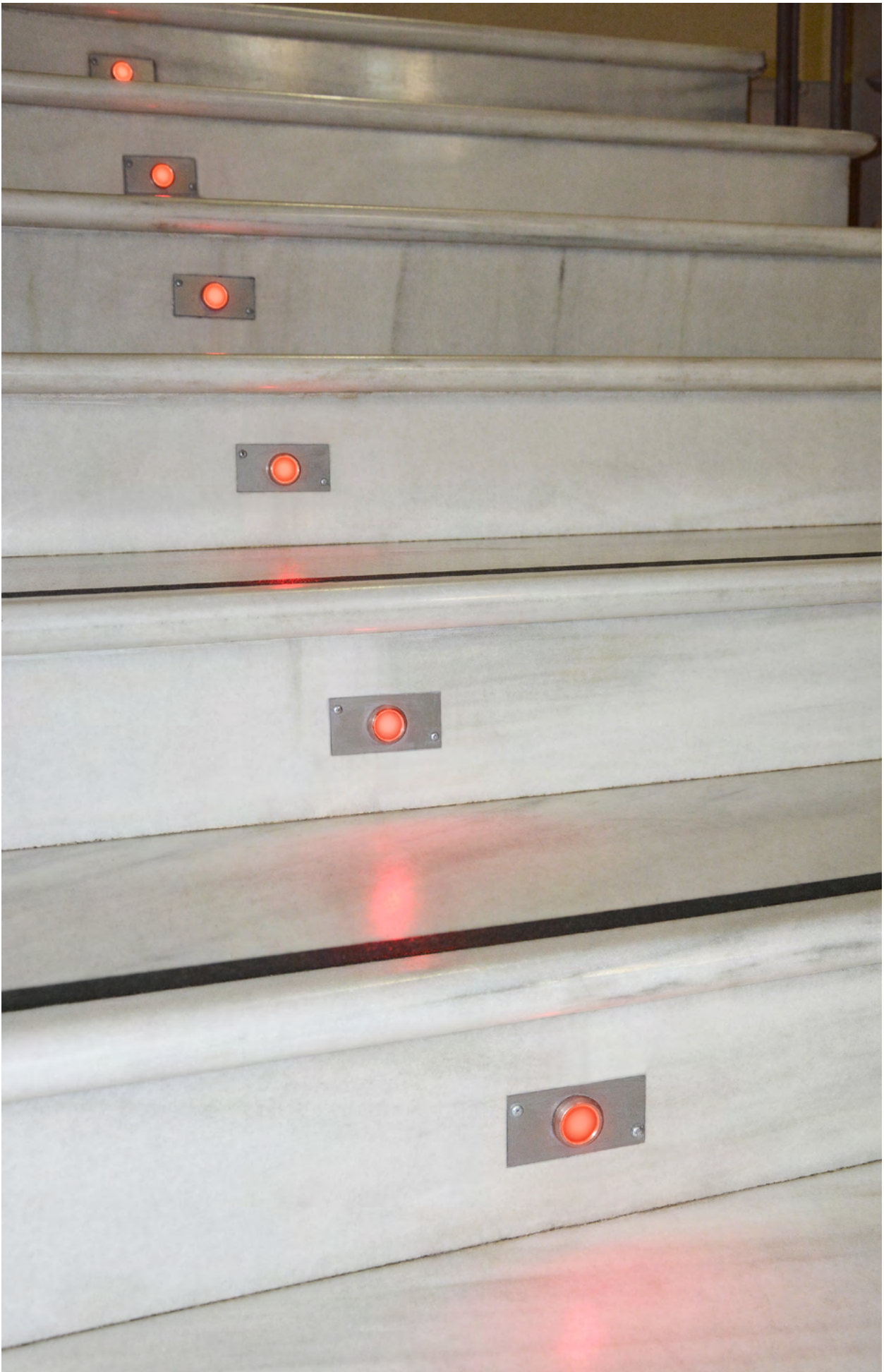

PCM Series CENTRALIZED

Beacon light of reduced dimensions and industrial yet modern aesthetics. Composed of a low-power central LED available in different colours. Centralized (powered by a centralizing device) and with maintained operation. AISI 304 stainless steel body.



Maintained

model	power supply	RRP (€)
PCM-B0	12 Vdc or 12 Vac	30.67

To request different LED colour or different diffuser type, change the corresponding letters in the reference. Example:

LED colour | B □ Y ■ V ■ A ■ R ■
 PCM-YT
 Diffuser | T Transparent
 O Opal

- ◇ Fastening by means of adhesive paste or optional stainless steel nut M18x1:
Ref. M01388INOX
RRP. 3.29 €
- ◇ Stainless steel frames for universal boxes or other sizes available on request.

Centralizing devices

- ◇ The centralizing device powers the beacons at 12 Vdc, both in presence of the mains (maintained) and in emergency mode.
- ◇ Metal wall mounting cabinet with front door, epoxy painted grey RAL 7035.
- ◇ With remote control input.
- ◇ Ni-Cd (HT) battery.
- ◇ Each device can power a maximum number of beacons ensuring a 1 hour autonomy in emergency mode.

model	A (h)	beacons	dimensions (mm)	RRP (€)
EPM-24	1	24	400 x 300 x 150	510.39
EPM-64	1	64	400 x 300 x 150	611.54
EPM-112	1	112	400 x 300 x 150	815.68
EPM-224	1	224	500 x 400 x 200	1,346.67

Technical characteristics

- ◇ Electrical insulation Class III
- ◇ Remote controllable Yes (centralizing device)
- ◇ Protection rating IP67, IK08

Surface mounting

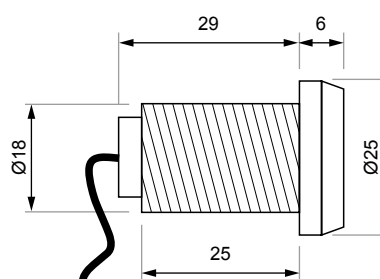



LN Series

Rectangular, watertight LED emergency fitting with a modern design and LED strip lighting (colour temperature: 5,700 K), for surface mounting. Includes soft opal internal diffuser in high transmittance material for optimum protection of the LEDs and homogeneous and pleasant lighting. Remote controllable.



Non maintained

model	Φ (lm)	A (h)	size	P net (W)	RRP (€)
LN1-450	450	1	1	1.5	137.09
LN1-1200	1,200	1	1	3.0	163.86
LN1-2400	2,400	1	2	4.5	238.83
LN1-4800	4,800	1	2	6.5	317.02
LN2-600	600	2	1	3.0	156.37
LN2-1200	1,200	2	2	4.5	224.91
LN2-2400	2,400	2	2	6.5	303.09

Centralizable fittings

model	Φ (lm)	size	P net (W)	RRP (€)
LN-1200L1	1,200	1	10.5	124.24
LN-2400L1	2,400	1	20.0	153.15
LN-2400L2	2,400	2	20.0	189.57
LN-4800L2	4,800	2	33.0	253.83

The supply voltage of all centralizable fittings is 85 to 265 Vac and 120 to 370 Vdc.

Maintained

model	Φ (lm) emerg	Φ (lm) main	A (h)	size	P net (W)	RRP (€)
LN1-450P1200	450	1,200	1	1	11.0	181.00
LN1-1200P1200	1,200	1,200	1	1	14.0	200.28
LN1-900P2400	900	2,400	1	2	22.0	258.11
LN1-2400P2400	2,400	2,400	1	2	24.0	296.67
LN1-1800P4800	1,800	4,800	1	2	35.0	347.00
LN2-600P1200	600	1,200	2	1	14.0	200.28
LN2-450P2400	450	2,400	2	2	22.0	258.11
LN2-1200P2400	1,200	2,400	2	2	24.0	296.67
LN2-900P4800	900	4,800	2	2	35.0	347.00

◇ Protection rating: IP65.

◇ Ni-Cd (HT) battery.

Surface mounting

Size 1

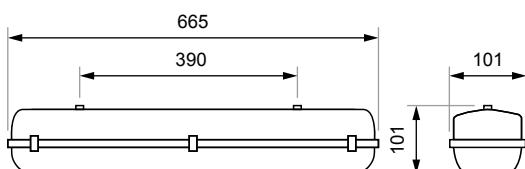

Size 2

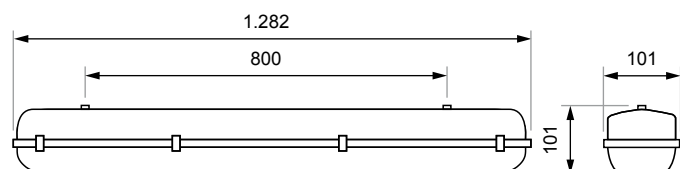



LN Series AUTOTEST

Waterproof LED emergency fitting with Autotest function: a microprocessor checks the status of the emergency LEDs, the battery and the electronics on a regular basis. Modern design and LED strip lighting (colour temperature: 5,700 K) with soft opal internal diffuser in high transmittance material. Remote controllable.



Non maintained

model	Φ (lm)	A (h)	size	P net (W)	RRP (€)
LNA1-450	450	1	1	1.5	164.91
LNA1-1200	1,200	1	1	3.0	191.69
LNA1-2400	2,400	1	2	4.5	266.66
LNA1-4800	4,800	1	2	6.5	344.84
LNA2-600	600	2	1	3.0	184.19
LNA2-1200	1,200	2	2	4.5	252.74
LNA2-2400	2,400	2	2	6.5	330.92

Maintained

model	Φ (lm) emerg	Φ (lm) main	A (h)	size	P net (W)	RRP (€)
LNA1-450P1200	450	1,200	1	1	11.0	208.82
LNA1-1200P1200	1,200	1,200	1	1	14.0	228.10
LNA1-900P2400	900	2,400	1	2	22.0	285.94
LNA1-2400P2400	2,400	2,400	1	2	24.0	324.49
LNA1-1800P4800	1,800	4,800	1	2	35.0	374.83
LNA2-600P1200	600	1,200	2	1	14.0	228.10
LNA2-450P2400	450	2,400	2	2	22.0	285.94
LNA2-1200P2400	1,200	2,400	2	2	24.0	324.49
LNA2-900P4800	900	4,800	2	2	35.0	374.83

◇ Protection rating: IP65.

◇ Ni-Cd (HT) battery.

◇ Information about Autotest on page 93.

Surface mounting

Size 1

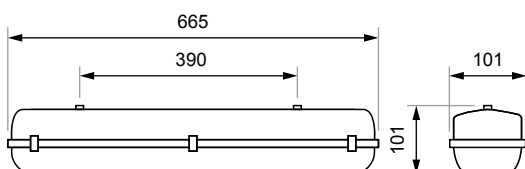

Size 2

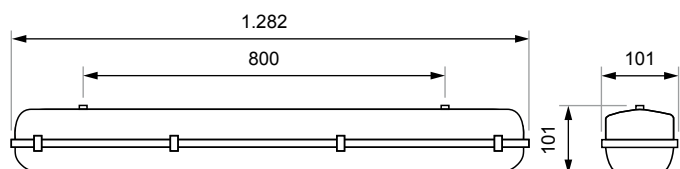



Tube Series

Cylindrical, watertight LED emergency fitting. It fits into two supports that allow the fitting to rotate, permitting the light beam to be directed. Lighting by means of LED strip with internal diffuser in high transmittance material for optimum protection of the LEDs and homogeneous and pleasant lighting.



Non maintained

model	Φ (lm)	A (h)	LEDs	P net (W)	RRP (€)
LTL-200	200	1	4	1.5	127.49
LTL-450	450	1	9	2.6	132.70
LTL-800	800	1	16	3.0	175.34
LTL-1200	1,200	1	24	3.0	184.21
LTL-100-2	100	2	2	1.5	126.46
LTL-200-2	200	2	4	2.6	131.57
LTL-400-2	400	2	8	3.0	172.05
LTL-600-2	600	2	12	3.0	184.21
LTL-150-3	150	3	3	2.6	131.57
LTL-250-3	250	3	5	3.0	170.42
LTL-400-3	400	3	8	3.0	184.21

- ◇ Protection rating: IP67.
- ◇ Ni-Cd (HT) or Li-Ion battery, according to the model.
- ◇ The cable entry is from the side and is supplied with a cable gland size PG-11.
- ◇ Vandal-proof fastening: replacement of the two standard plastic brackets in which the luminaire fits with two screwed metal brackets.

Ref. Vandal-proof flange
RRP. 13.48 €



Maintained

model	Φ (lm)	A (h)	LEDs	P net (W)	RRP (€)
LTL-450P	450	1	9	7.5	143.94
LTL-200P-2	200	2	4	4.9	143.94
LTL-150P-3	150	3	3	4.4	143.94

To request the supplement of the two brackets for vandal-proof fastening, add "(AV)" to the reference. Example:

LTL-1200 (AV)

Fastening | Standard brackets
(AV) Vandal-proof brackets (+18.21 €)

Surface mounting

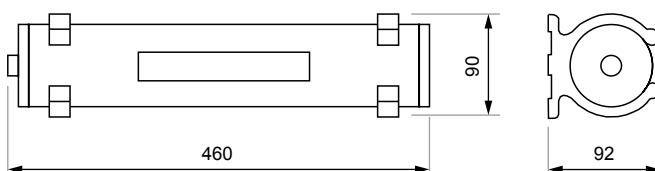

K1 Series FLUORESCENT TUBES

Kit for converting fluorescent tubes to emergency. Set consisting of a charger-converter and one or two batteries, to convert linear or compact fluorescent tubes. Allows non-maintained or maintained operation by means of external ballast depending on the connection. Remote controllable.



Linear tubes T8

model	A (h)	18 W	36 W	58 W	RRP (€)
K-715	1	44%	22%	15%	57.79
K-730	1	88%	44%	30%	82.54
K-730A	2	44%	22%	15%	82.54

Lineal tubes T5

model	A (h)	80 W	RRP (€)
K-715T80	1	11%	57.79
K-730T80	1	22%	82.54
K-730AT80	2	11%	82.54

Linear tubes T5

model	A (h)	14 W	21 W	28 W	35 W	49 W	54 W	RRP (€)
K-715T	1	58%	45%	33%	29%	18%	16%	57.79
K-730T	1	100%	90%	66%	58%	36%	32%	82.54
K-730AT	2	58%	45%	33%	29%	18%	16%	82.54

Compact U tubes (G24 and 2G11)

model	A (h)	10W G24Q-1	13W G24Q-1	18W G24Q-2	26W G24Q-3	18W 2G11	24W 2G11	36W 2G11	RRP (€)
K-715	1	86%	66%	48%	33%	44%	36%	22%	57.79
K-730	1	100%	100%	96%	66%	88%	72%	44%	82.54
K-730A	2	86%	66%	48%	33%	44%	36%	22%	82.54

Battery

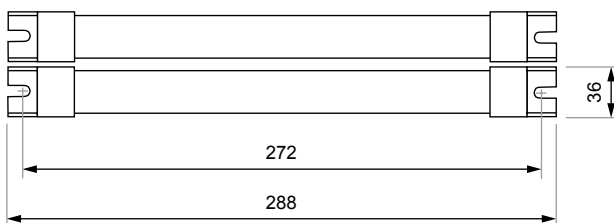

- ◊ The K-715 and all its variations use a single battery, while the K-730 and all its variations use two batteries.
- ◊ The kits are suitable for tubes with conventional ballast and electronic ballast, but not for compact tubes with built-in starter (2 pins).
- ◊ Ni-Cd (HT) battery.

Charger-converter

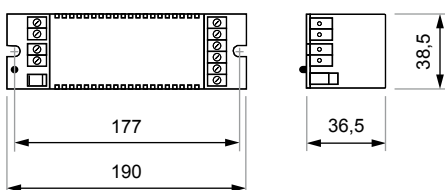

K2 Series LED STRIPS

Kit for converting LED strips and other devices that operate a 12 Vdc, such as halogen lamps or fire sirens. Set consisting of a charger-converter and two batteries, that allow a maintained or non-maintained functioning depending on the connection. Remote controllable.



Devices at 12 Vdc

model	A (h)	power	battery	RRP (€)
K-124	1	38 W	Ni-Cd (HT)	184.98

Charger-converter

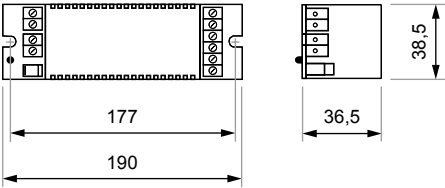

Battery

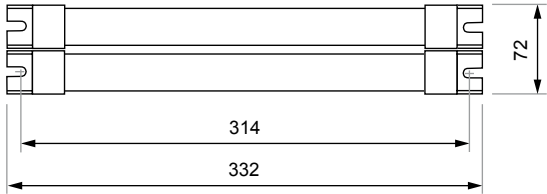



PL Series

Emergency floodlight with LED spotlights. One, two or four spotlights fitted with LED strips (colour temperature: 5,700 K) with dispersed light beam, non-orientable, for installation at great heights. Metal body with epoxy paint in white RAL 9010 (IP42) and grey RAL 7035 (IP66). Remote controllable.



Non maintained IP42

model	Φ (lm)	A (h)	spots	P net (W)	RRP (€)
PL1-1200	1,200	1	1	3.0	135.02
PL1-1800	1,800	1	4	10.4	316.49
PL1-2400	2,400	1	2	4.3	370.97
PL1-3600	3,600	1	4	6.6	479.95
PL1-4800	4,800	1	4	6.6	554.15
PL2-1200	1,200	2	2	4.3	355.91
PL2-1800	1,800	2	2	6.6	396.48
PL2-2400	2,400	2	2	6.6	463.71

Maintained IP42

model	Φ (lm)	A (h)	spots	P net (W)	RRP (€)
PL1-1800P	1,800	1	4	30.0	382.56

Non maintained IP66

model	Φ (lm)	A (h)	spots	P net (W)	RRP (€)
PL1-1200E	1,200	1	1	3.0	162.54
PL1-1800E	1,800	1	4	10.4	513.57
PL1-2400E	2,400	1	2	4.3	515.88
PL1-3600E	3,600	1	4	6.6	685.14
PL1-4800E	4,800	1	4	6.6	765.12
PL2-1200E	1,200	2	2	4.3	499.66
PL2-1800E	1,800	2	2	6.6	542.55
PL2-2400E	2,400	2	2	6.6	613.26

Maintained IP66

model	Φ (lm)	A (h)	spots	P net (W)	RRP (€)
PL1-1800PE	1,800	1	4	30.0	581.96



PL Series

- ◇ The PL1-1200 is the only single spot floodlight with a Li-Ion battery, while the others have Ni-Cd (HT) batteries.
- ◇ This model does not include a metal body, but consists of the spotlight itself with a system of epoxy-painted steel plates that allow it to be oriented in any direction:

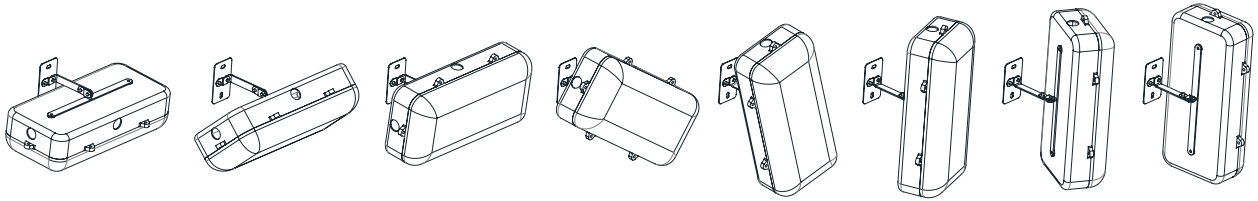

- ◇ IP42 floodlight: soft opal diffuser as standard and transparent or strong opal as an option. The floodlight is opened by folding down the cover with respect to the base fixed on the wall. The cover rests at 90°, allowing easy handling of the interior.
- ◇ IP66 floodlight: transparent diffuser as standard and soft or strong opal as an option. The floodlight housing is a watertight metal cabinet with lockable door.
- ◇ The protection rating of the PL1-1200E model with a single spotlight is IP67.

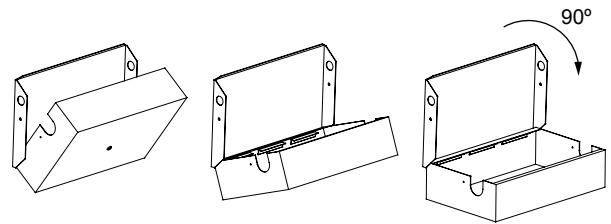

Surface mounting

Single spotlight floodlight IP42

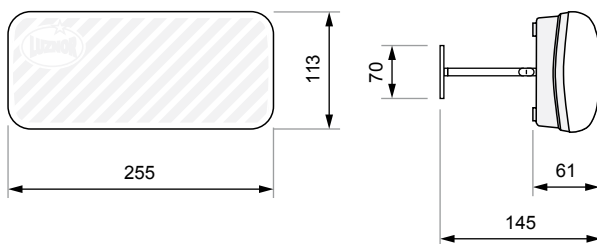

Single spotlight floodlight IP67

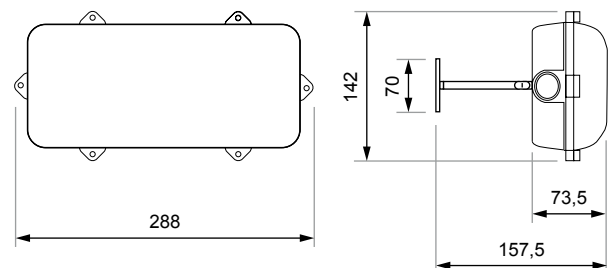

Two spotlight floodlight IP42

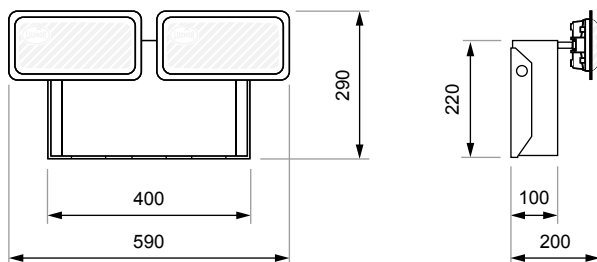

Two spotlight floodlight IP66

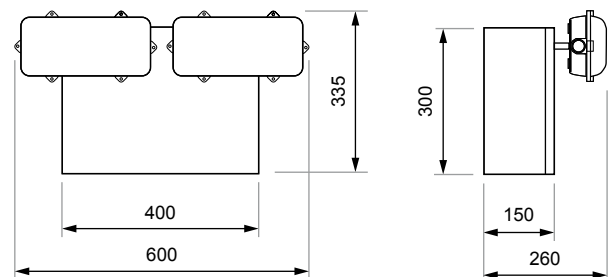

Four spotlight floodlight IP42

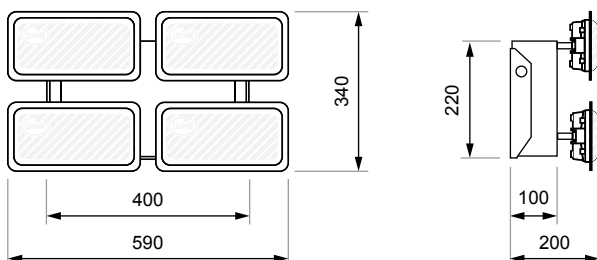

Four spotlight floodlight IP66

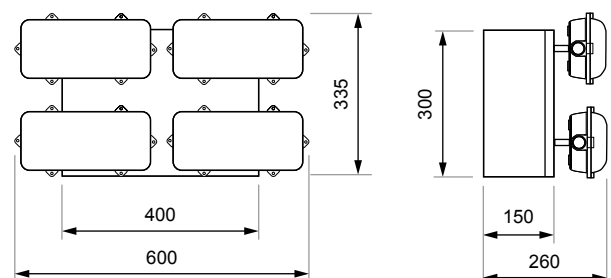



PH Series

Carefully designed emergency floodlight with spotlights that can be adjusted in any direction. Two or four spotlights (colour temperature: 5,000 K) with a concentrated lightbeam and high energy efficiency for installation at great heights. Small metal housing with epoxy paint in RAL 7035 grey. Remote controllable.



Non-maintained

model	Φ (lm)	A (h)	spots	P net (W)	RRP (€)
PH1-1000	1,000	1	2	2.0	308.65
PH1-2000	2,000	1	4	3.6	447.93
PH2-1000	1,000	2	2	3.6	330.94
PH2-2000	2,000	2	4	6.4	527.05

To request IP66 degree of protection, add the letter "E" to the part number. Example:

PH1-1000PE
 ↳ Protection | IP42
 E IP66 (+88.03 €)

- ◇ Dimensions on page 77.
- ◇ Interdistances on page 86.
- ◇ Ni-Cd (HT) battery.

Maintained

model	Φ (lm)	A (h)	spots	P net (W)	RRP (€)
PH1-1000P	1,000	1	2	13.0	379.97
PH1-2000P	2,000	1	4	24.0	519.25
PH2-1000P	1,000	2	2	15.0	402.25
PH2-2000P	2,000	2	4	17.0	597.24

- ◇ Floodlight IP66: the housing of the floodlight is a watertight metallic wall cabinet with lockable door.
- ◇ Floodlight IP42: The floodlight is opened by folding down the cover with respect to the base fixed on the wall. The cover rests at 90°, allowing east handling of the interior:

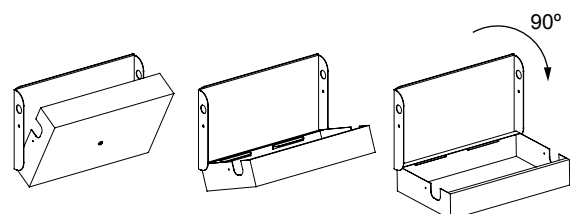



PH Series AUTOTEST

Carefully designed emergency floodlight with Autotest function: a microprocessor checks the status of the emergency LEDs, the battery and the electronics periodically. Two or four adjustable LED spotlights with concentrated lightbeam and high energy efficiency. Small metal housing. Remote controllable.



Non-maintained

model	Φ (lm)	A (h)	spots	P net (W)	RRP (€)
PHA1-1000	1,000	1	2	2.0	336.48
PHA1-2000	2,000	1	4	3.6	475.76
PHA2-1000	1,000	2	2	3.6	358.76
PHA2-2000	2,000	2	4	6.4	554.87

Maintained

model	Φ (lm)	A (h)	spots	P net (W)	RRP (€)
PHA1-1000P	1,000	1	2	13.0	407.80
PHA1-2000P	2,000	1	4	24.0	547.08
PHA2-1000P	1,000	2	2	15.0	430.07
PHA2-2000P	2,000	2	4	17.0	625.07

To request IP66 degree of protection, add the letter "E" to the reference. Example:

PHA1-2000E
 Protection | IP42
 E IP66 (+88.03 €)

- ◇ Information about Autotest on page 87.
- ◇ Interdistances on page 86.
- ◇ Ni-Cd (HT) battery.

◇ Highest adjustability of the market:

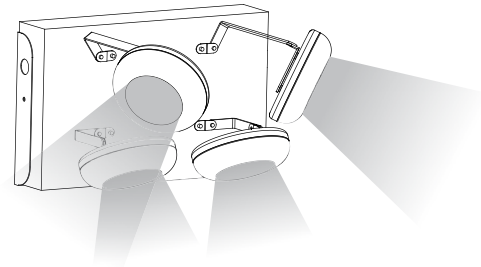

Surface mounting

IP42 floodlight with two spotlights

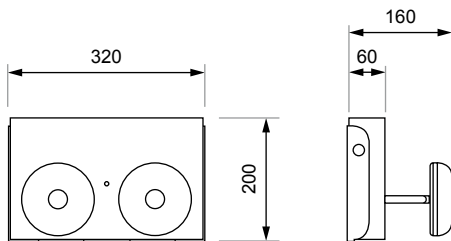

IP66 floodlight with two spotlights

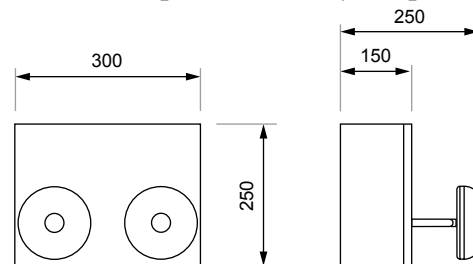

IP42 floodlight with four spotlights

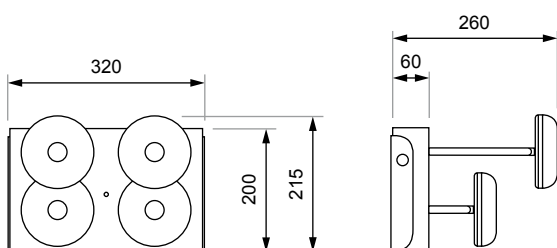

IP66 floodlight with four spotlights

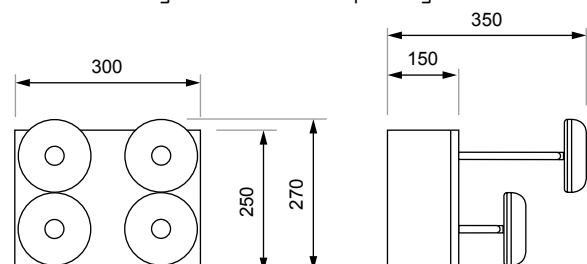





◊ It is possible to request a General Rapport of Seismic Qualification. Example of registered response spectrum (5%): horizontal (left) and vertical (right):

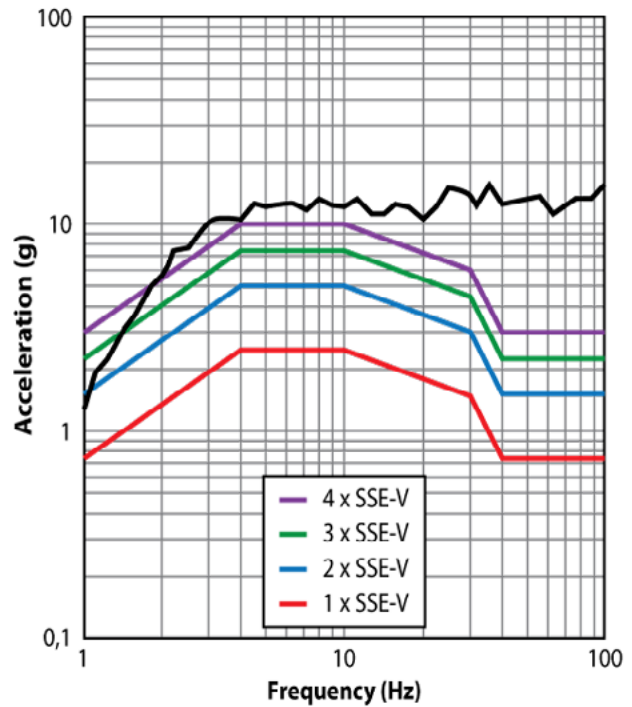
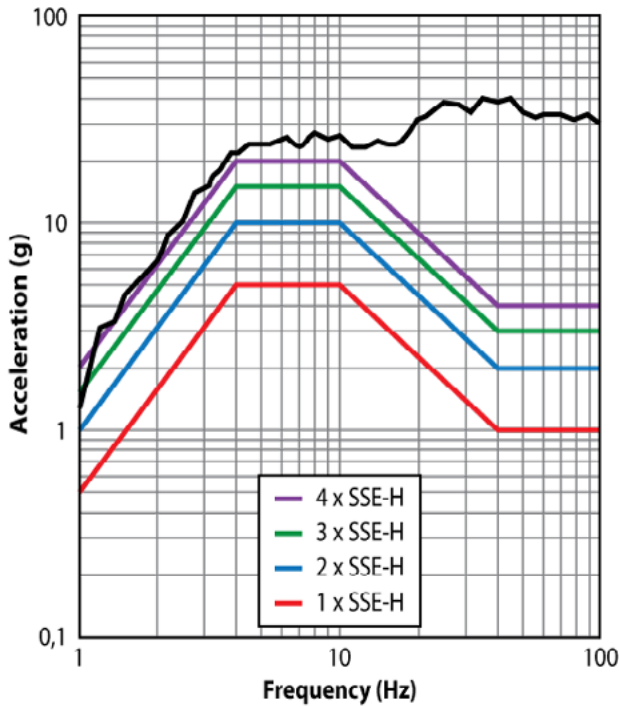

Technical characteristics

- ◊ Power supply 230 Vac
- ◊ Electrical insulation Class I
- ◊ Usage temperature -10°C ÷ 40°C
- ◊ Protection rating IP55, IK08
- ◊ Relative humidity 90% no condensation
- ◊ Consumption 24W (recharge)
5W (maintenance)
- ◊ Weight 20 kg (Pb battery)
13 kg (Ni-MH battery)

- ◊ Cable entry is possible by any side under demand, but, by default, it is made on the left side of the floodlight by means of a cable gland of size M20.
- ◊ Includes four AISI 304 stainless steel lugs for anchoring: the distances between shafts are compatible with other Luznor floodlights for quick replacement:

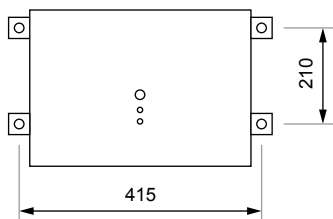

- ◊ The spotlights can be adjusted in any direction by means of two swivelling axes per spotlight.
- ◊ Interdistances on page 86.
- ◊ The collimator in each spotlight provides a circular directed beam:

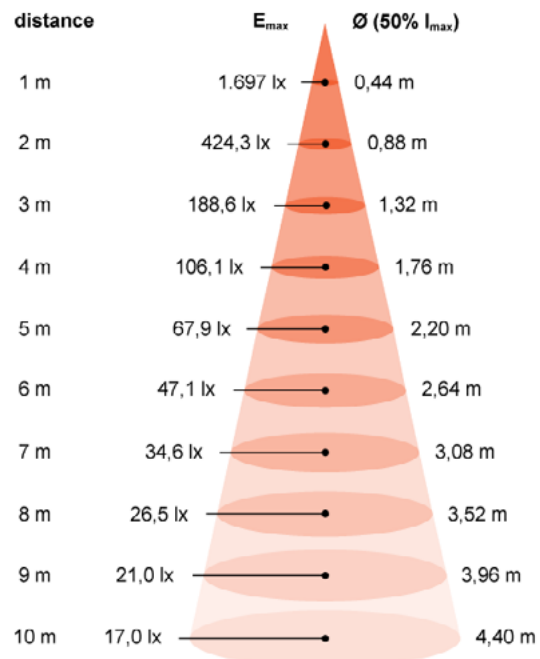

PLN Series

LED emergency floodlight with seismic qualification. Two adjustable LED spotlights with concentrated light-beam, (colour temperature: 5,000 K) and high energy efficiency to be installed at great heights in critical structures or areas with seismic risks, like hydroelectric and nuclear plants. Stainless steel housing. Remote controllable.



Non-maintained

model	Φ (lm)	A (h)	spots	battery	RRP (€)
PLN-1000AP	1,000	24	2 up	Pb	3,565.00
PLN-1000AN	1,000	24	2 up	Ni-MH	4,203.34
PLN-1000BP	1,000	24	2 front	Pb	3,565.00
PLN-1000BN	1,000	24	2 front	Ni-MH	4,203.34
PLN-2000P	2,000	12	4	Pb	3,998.59
PLN-2000N	2,000	12	4	Ni-MH	4,636.92



Seismic qualification according to IEEE-344.

Resists both structurally and functionally the earthquake and performs its safety function during and after the tremor.

It can withstand acceleration greater than 20 g in the horizontal plane and 10 g in the vertical plane.

◇ The battery, whether Pb (lead-acid) or Ni-MH (nickel-metal hydride), is watertight, maintenance-free, and does not release any gases.

Surface mounting

Floodlight with two upper spotlights

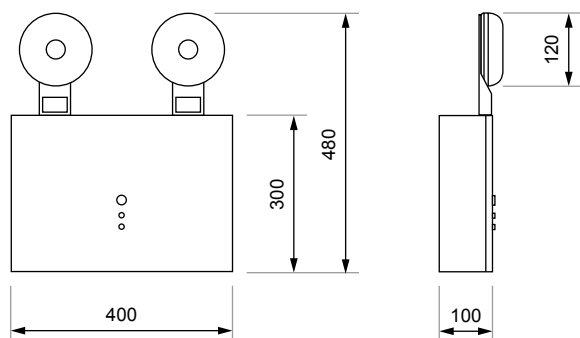

Floodlight with two front spotlights

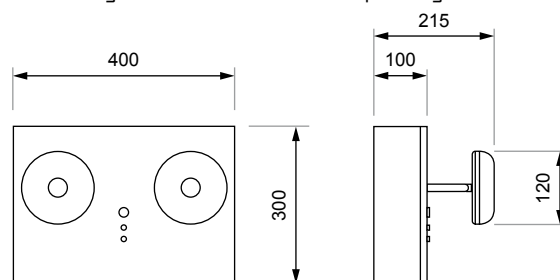



LH Series

Emergency floodlight with adjustable halogen spotlights. Two or four high durable halogen spotlights with concentrated lightbeam to be installed at great heights. Metal housing with RAL 7001 (IP42) and RAL 7035 (IP55) grey epoxy paint. Ni-Cd (HT) battery. Remote controllable.



Non-maintained

model	Φ (lm)	A (h)	spots	P net (W)	RRP (€)
LH1-410	410	1	2 x 10 W	5.1	317.05
LH1-820	820	1	4 x 10 W	9.2	469.86
LH1-950	950	1	2 x 20 W	9.2	372.40
LH1-1750	1,750	1	2 x 55 W	15.8	819.98
LH1-1900	1,900	1	4 x 10 W	14.5	601.95
LH2-410	410	2	2 x 10 W	9.2	372.40
LH2-950	950	2	2 x 20 W	14.5	507.64

◊ IP42 floodlight: The floodlight is opened by folding down the cover with respect to the base fixed on the wall. The cover rests at 90°, allowing east handling of the interior.

◊ IP55 floodlight: the housing of the floodlight is a watertight metal wall cabinet with lockable door.

To request IP55 protection rating, add the letter "E" to the reference. Example:

LH1-410E
 Protection | IP42
 E IP55 (+91.38 €)

Surface mounting

IP42 floodlight with two spotlights

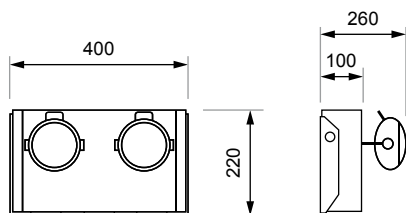

IP55 floodlight with two spotlights

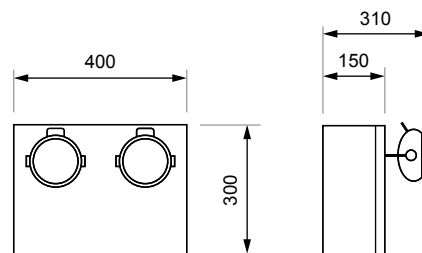

IP42 floodlights of two spotlights

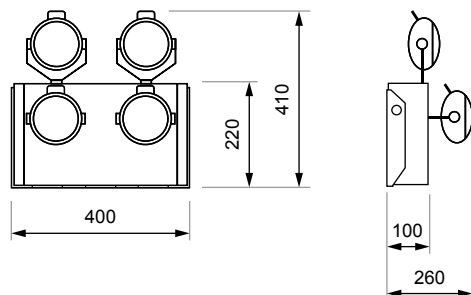

IP55 floodlight with four spotlights

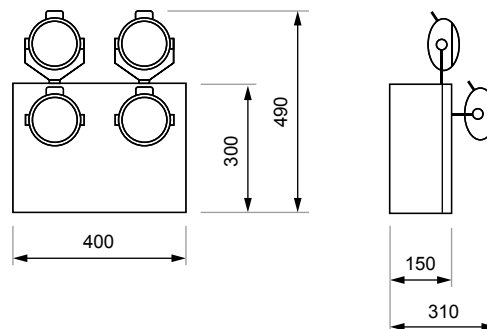



FI Led Series

LED emergency luminaire for low temperatures. This is a emergency luminaire of the LLE series adapted to work in a temperature range of -40 °C to 40 °C. The electronics regulate the temperature of the battery in any changing environment: cold chambers, contrast between night and day, etc. Remote controllable.



Non-maintained

model	Φ (lm)	A (h)	P net (W)	RRP (€)
FIL-250	250	1	23.0	131.09
FIL-450	450	1	23.0	147.48

Maintained

model	Φ (lm)	A (h)	P net (W)	RRP (€)
FIL-250B	250	1	26.0	147.48
FIL-450B	450	1	28.0	163.86

Surface mounting

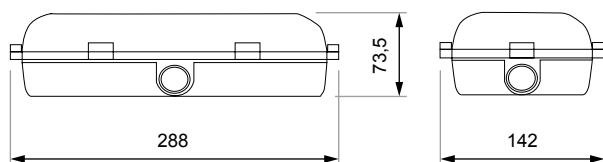

- ◇ Protection rating: IP67.
- ◇ Ni-Cd (HT) battery.
- ◇ Supplied with three cable gland entries for cable glands size PG-13.5 and two plugs with sealing gaskets.
- ◇ Colour temperature: 5,700 K (cold light).

Recessed mounting

Stainless steel frame

Cut: 300 x 160 mm



Ref. MBEL-I
386 x 196 mm
RRP. 25.54 €

Adjustable mounting

Epoxy-painted steel orientation set in grey RAL 7035



Ref. COBEL
RRP. 18.98 €



CB Series BATTERY CHARGING EQUIPMENT

Uninterruptible direct current power supply system. Equipment consisting of a charger and a battery, housed in an IP22 metal cabinet with lockable door, which provides DC output voltage, both in the presence and absence of mains power.



Possibilities of the standard range

output voltage (Vdc)	caliber (A)	capacity (Ah)
12 - 24 - 48 - 110 - 120	1 - 3 - 6 - 10	4 - 7 - 14

It is possible to request other output voltages and battery capacities: the range of CB equipment is very wide and totally customizable.

- ◇ The charger can simultaneously supply the charging intensity of the battery and the one required for the use of the recharge, up to the value of its total size.
- ◇ The battery can be either Ni-Cd (HT) or Pb, in both cases watertight, maintenance-free and without gas evolution.

Signalling and alarms

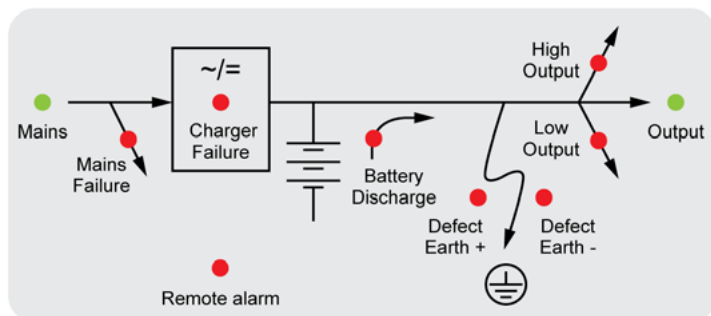

- ◇ It incorporates a synoptical label with LED diodes located on the door, with multiple status signals and alarms.
- ◇ The remote alarm is turned on after a time delay of 10-20 seconds since any alarm occurs. A potential-free inverter contact allows this alarm to be transmitted remotely.



CBQ Series OPERATING LIGHT EQUIPMENT

Uninterruptible power supply system in alternating current or direct current. Equipment providing AC output voltage in presence of mains and DC output voltage in absence of mains, in both cases 24 V. Other voltages can be established on request.



Possibilities of the standard range

output voltage	A (h)	power (w)
24 Vac or 24 Vdc	1 or 2	300 - 600 - 1,100

It is possible to request other output voltages and powers: the CBQ equipment range is very wide and totally customizable.

- ◇ Equipment consisting of a battery charger, a battery that provides output voltage when a mains failure occurs, a transformer that provides AC output voltage and a contactor that performs the output switch to the transformer or to the battery.
- ◇ The battery is Pb: watertight, maintenance-free and without gas evolution.

Signalling and alarms

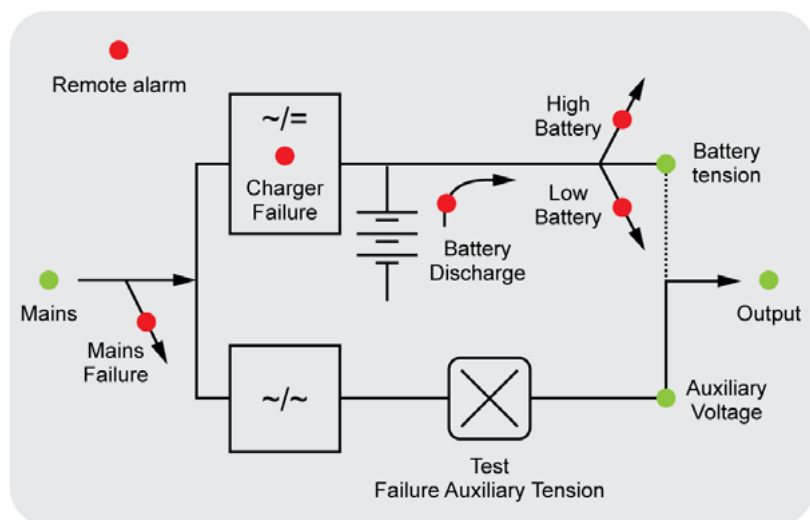

- ◇ It incorporates a synoptical label with LED diodes located on the door, with multiple status signals and alarms.
- ◇ The remote alarm is turned in after a time delay of 10-20 seconds since any alarm occurs. A potential-free inverter contact allows this alarm to be transmitted remotely.

Interdistances

The interdistance is the maximum distance at which two luminaires may be positioned so as to ensure a minimum horizontal illumination level of 1 lux along the escape route.

Polar Series

model	height (m)			
	2.5	3.0	3.5	5.0
300 lm T ☉ → ☉	9.7	10.4	11.4	13.3
300 lm T ☉ → ☞	4.0	4.3	4.7	5.2
300 lm S ☉ → ☉	10.1	10.9	11.6	13.1
300 lm S ☉ → ☞	4.1	4.3	4.6	5.0
200 lm T ☉ → ☉	8.6	9.6	10.1	11.6
200 lm T ☉ → ☞	3.6	3.9	4.1	4.4
200 lm S ☉ → ☉	8.9	9.6	10.0	11.3
200 lm S ☉ → ☞	3.6	3.8	4.0	4.1
150 lm T ☉ → ☉	8.1	8.7	9.4	10.8
150 lm T ☉ → ☞	3.3	3.5	3.7	3.5
150 lm S ☉ → ☉	8.2	8.7	9.3	10.0
150 lm S ☉ → ☞	3.3	3.4	3.5	3.5

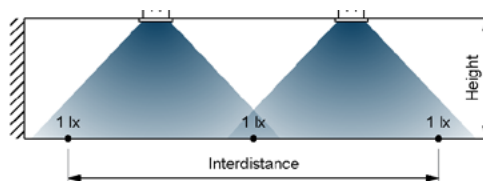

Note: These distances are approximate. They serve as a reference only in the case of linear escape routes such as corridors and in no case have the equivalent validity of a lighting study carried out using the Luznor PCI Software.

PH and PLM Series

For each height at which two adjacent floodlights are positioned, there is an optimum angle of aiming of the spotlights, which allows maximum interdistance between the floodlights.

model	height (m)							
	5		10		15		20	
1,000 lm (2 focus) ☞ → ☞	24.0	(a ₁ =45°)	26.0	(a ₁ =32°)	30.0	(a ₁ =26°)	32.0	(a ₁ =23°)
1,000 lm (2 focus) ☞ → ☞	10.5	(a ₁ =45°)	12.0	(a ₁ =32°)	13.5	(a ₁ =26°)	14.5	(a ₁ =23°)
2,000 lm (4 focus) ☞ → ☞	44.0	(a ₁ =45°, a ₂ =80°)	61.0	(a ₁ =32°, a ₂ =70°)	66.0	(a ₁ =26°, a ₂ =70°)	67.0	(a ₁ =23°, a ₂ =55°)
2,000 lm (4 focus) ☞ → ☞	18.5	(a ₁ =45°, a ₂ =80°)	23.0	(a ₁ =32°, a ₂ =70°)	24.0	(a ₁ =26°, a ₂ =70°)	24.0	(a ₁ =23°, a ₂ =55°)

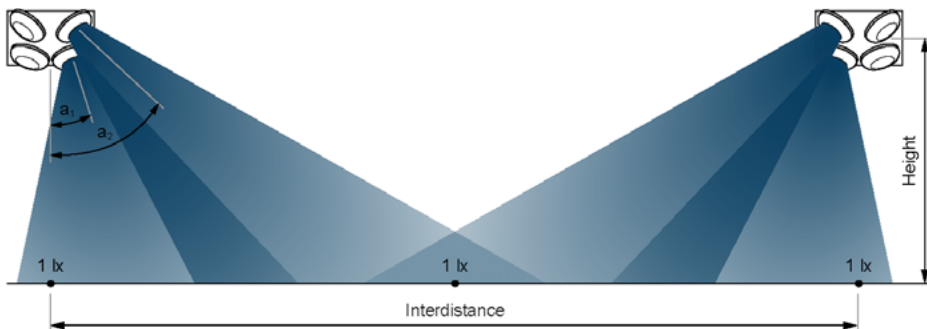

Autotest FUNCTIONING

◊ Each emergency luminaire checks constantly the battery status and the electronics in the presence of mains power and performs automatically two types of different tests:

test	verification	duration	frequency
Functional	lamp, battery and electronics	6 min	3 months
Autonomy	lamp, battery, electronics and autonomy	1, 2 or 3 h (autonomy in emergency)	12 months

◊ In case of failure, this is indicated on the emergency luminaire by a red LED, whether the luminaire is connected to mains or in emergency mode. After solving the fault, the *reset* button must be pressed during 3 seconds to inform the luminaire that it has been restored.

◊ Possible signals:

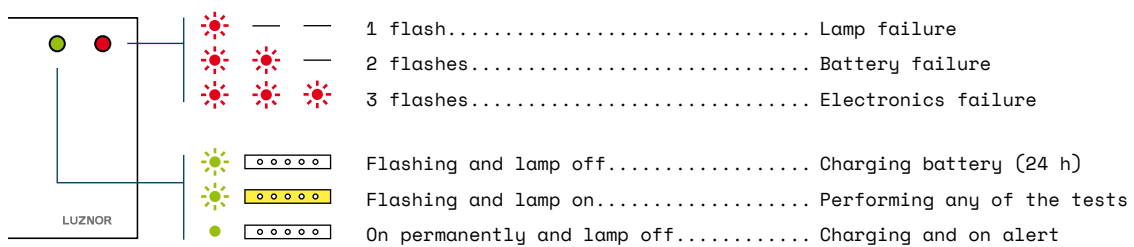

Sales terms 2023

OBJECT

The present sales terms are intended to define the commercial relationship between the company Luznor and its customers, which must be mutually beneficial, free and respectful at all times, without exercising dominant or coercive actions.

ORDERS

Upon receipt of an order, Luznor will send the customer an order acknowledgement indicating the price, delivery time and other specific conditions of the order. The order acknowledgement and the general sales terms will be the only valid contractual documents and will be understood to be accepted by the customer regardless of any other documents that may have been provided.

The delivery time indicated shall refer to the maximum date foreseen for leaving the factory. The delay in delivery, for reasons beyond Luznor's control, shall not be subject to rejection, cancellation or penalty.

The minimum order value is €50 before tax.

SALES PRICES

The sales prices will be those defined in Luznor's 2023 emergency lighting catalogue, those quoted in specific offers or those adjusted to the particular conditions agreed with the customer and always subject to VAT and taxes in force. The prices published in this catalogue may be revised unilaterally by Luznor.

PAYMENT TERMS

According to the law in force 15/2010 of 07 July 2010, from 01 January 2013 the maximum payment term will be 60 days, counting from the date of receipt of the goods.

For orders of less than €300 before tax, payment will be made in advance by bank transfer.

TRANSPORT

For deliveries in mainland Spain and the Balearic Islands for amounts over €500 before tax, postage will be paid and, if not, will be charged to the customer on the invoice: €13 for one package and €18 for two packages. For deliveries to the Canary Islands, postage will be paid for amounts exceeding €950 before tax.

Deliveries involving postage to be paid by the customer will be made through the agency indicated by the customer or, alternatively, will be charged by Luznor in the invoice. When the delivery is made through the customer's agency, the transport will be at the customer's risk, exempting Luznor from any responsibility.

Upon receipt of the goods, regardless of the method of shipment, the customer must examine them to give their approval. If any incident is noticed due to deterioration, missing numbers or any other reason, a complaint must be made to the agency and simultaneously to Luznor, at the very moment of reception.

Luznor will not accept claims of this kind after 4 days from receipt of the goods.

RETURNS

Whatever the reason, Luznor will not accept the return of any goods invoiced more than 3 months old.

Prior to returning the material, the customer must inform the factory, at which time Luznor will issue the return authorisation form indicating the corresponding shipping instructions.

In the case of returns accepted by Luznor for crediting, this will be carried out with a minimum depreciation of 20%, as reception, revision and conditioning expenses. Returns of goods considered to be of special manufacture will not be accepted.

WARRANTY

Luznor products enjoy a 2-year warranty, which covers any manufacturing defects. Fluorescent tubes, halogen lamps, batteries or other components considered consumables are not covered by the warranty.

The warranty is conditional upon proper storage, installation and use of the product by the customer. The warranty excludes faults caused by incorrect installation, improper handling, negligence or external causes.

Products that have been modified or manipulated by non-Luznor personnel will not be covered under warranty.

RATES

The values of the recycling rates imposed on each product are not published in this catalogue and will be available on the Luznor website. These rates are only applicable to products sold on Spanish territory.

PRIVACY POLICY

Personal data will be processed by LUZNOR DESARROLLOS ELECTRÓNICOS, S.L., to maintain contact and communication, manage the contractual and/or commercial relationship with current and/or potential customers and suppliers and, where appropriate, send them information about our activities, products and/or services. This processing is based on: contractual and/or commercial relationship and our legitimate interest. We do not communicate data to third parties, unless legally obliged to do so. You may, where appropriate, exercise the rights recognised by the LOPD, as detailed in the privacy policy of www.luznor.com.

CODE OF CONDUCT

The customer is obliged at all times to comply with the legislation in force. The customer shall not commit, actively or passively, directly or indirectly, any kind of bribery, any violation of the basic fundamental rights of employees, nor shall it employ minors. Furthermore, the customer shall be responsible for the safety and health of its workers. It shall act in compliance with applicable environmental laws and will endeavour to promote this code of conduct among its suppliers and customers.

JURISDICTION

Any dispute between the parties, regardless of its nature or cause, shall be submitted to the jurisdiction of the courts of Vitoria-Gasteiz, excluding any other jurisdiction.

Regulations

European Parliament and Council Directives for compliance with the CE Marking Directive 93/68/EEC:

- ◇ 2014/35/EU *Making available on the market of electrical equipment designed for use within certain voltage limits*
- ◇ 2014/30/EU *Electromagnetic compatibility*
- ◇ 2011/65/EU *Restriction of the use of certain hazardous substances in electrical and electronic equipment*

Other European Parliament and Council Directives:

- ◇ 2006/66/CE *Batteries and accumulators and waste batteries and accumulators*
- ◇ 2006/25/CE *Minimum health and safety requirements regarding the exposure of workers to the risks arising from physical agents (artificial optical radiation)*

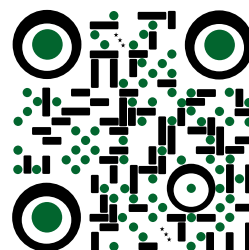

c/ Paduleta, 47 (Júndiz)
01015 Vitoria-Gasteiz (Álava)
Spain
www.luznor.com
luznor@luznor.com
Tel. (+34) 945 200 961